

# S110 and S310 Series Switches

## Hardware Description

**Issue** 02  
**Date** 2023-05-20



**Copyright © Huawei Technologies Co., Ltd. 2023. All rights reserved.**

No part of this document may be reproduced or transmitted in any form or by any means without prior written consent of Huawei Technologies Co., Ltd.

## **Trademarks and Permissions**



HUAWEI and other Huawei trademarks are trademarks of Huawei Technologies Co., Ltd.

All other trademarks and trade names mentioned in this document are the property of their respective holders.

## **Notice**

The purchased products, services and features are stipulated by the contract made between Huawei and the customer. All or part of the products, services and features described in this document may not be within the purchase scope or the usage scope. Unless otherwise specified in the contract, all statements, information, and recommendations in this document are provided "AS IS" without warranties, guarantees or representations of any kind, either express or implied.

The information in this document is subject to change without notice. Every effort has been made in the preparation of this document to ensure accuracy of the contents, but all statements, information, and recommendations in this document do not constitute a warranty of any kind, express or implied.

## **Huawei Technologies Co., Ltd.**

Address: Huawei Industrial Base  
Bantian, Longgang  
Shenzhen 518129  
People's Republic of China

Website: <https://www.huawei.com>

Email: [support@huawei.com](mailto:support@huawei.com)

---

# Contents

---

<b>1 About This Document.....</b>	<b>1</b>
<b>2 Using the Info-Finder.....</b>	<b>3</b>
<b>3 Version Requirements for Components.....</b>	<b>4</b>
<b>4 Chassis.....</b>	<b>5</b>
4.1 Chassis Overview.....	5
4.2 Naming Conventions.....	5
4.3 S110.....	7
4.3.1 S110-8P2ST (98012195).....	7
4.3.2 S110-8P2ST (98012269).....	12
4.3.3 S110-16LP2SR.....	18
4.3.4 S110-24T2SR.....	23
4.3.5 S110-24LP2SR.....	28
4.4 S310.....	33
4.4.1 S310-24T4S.....	33
4.4.2 S310-24P4S.....	38
4.4.3 S310-48T4S.....	45
<b>5 Cables.....</b>	<b>51</b>
5.1 Ground Cable.....	51
5.2 Optical Fiber.....	52
5.3 Ethernet Cable.....	56
5.4 AC Power Cable.....	59
5.5 Console Cable.....	62
<b>6 Pluggable Modules for Interfaces.....</b>	<b>64</b>
6.1 Important Notes About Using Optical Modules Certified for Huawei Switches.....	64
6.1.1 How to Identify Huawei-Certified Switch Optical Modules.....	64
6.1.2 Risks of Using Non-Huawei-Certified Switch Optical Modules.....	65
6.2 Understanding Optical Modules.....	66
6.2.1 What Is an Optical Module.....	66
6.2.2 Parameter Description.....	68
6.2.3 How to View Optical Module Parameters.....	70
6.2.4 Rules for Optical Module Interoperation.....	70

6.3 Understanding Copper Modules.....	71
6.4 FE SFP/eSFP Optical Modules.....	71
6.4.1 SFP-FE-LX-SM1310-BIDI.....	72
6.4.2 SFP-FE-LX-SM1550-BIDI.....	73
6.4.3 SFP-FE-SX-MM1310.....	74
6.4.4 eSFP-FE-LX-SM1310.....	74
6.5 GE eSFP Optical Modules.....	75
6.5.1 LE2MGSC40DE0.....	75
6.5.2 LE2MGSC40ED0.....	76
6.5.3 S-SFP-GE-LH40-SM1310.....	77
6.5.4 S-SFP-GE-LH40-SM1550.....	78
6.5.5 S-SFP-GE-LH80-SM1550.....	79
6.5.6 SFP-GE-BXU1-SC.....	80
6.5.7 SFP-GE-EX-C.....	80
6.5.8 SFP-GE-LX-SM1310 (02315200).....	81
6.5.9 SFP-GE-LX-SM1310-BIDI (02315285).....	82
6.5.10 SFP-GE-LX-SM1490-BIDI (02315286).....	83
6.5.11 SFP-GE-LX10-C.....	84
6.5.12 SFP-GE-SX-C (02312UUB).....	85
6.5.13 SFP-GE-ZBXD1.....	86
6.5.14 SFP-GE-ZBXU1.....	87
6.5.15 eSFP-GE-SX-MM850 (02315204).....	88
6.5.16 eSFP-GE-ZX100-SM1550.....	89
6.5.17 OGSC10DD0.....	89
6.5.18 OGSC40DD0.....	90
6.5.19 OGSM01880.....	91
6.5.20 SFP-GE-BX-D1-I.....	92
6.5.21 SFP-GE-BX-U1-I.....	93
6.5.22 SFP-GE-BX40-D-I.....	94
6.5.23 SFP-GE-BX40-U-I.....	95
6.5.24 eSFP-GE-SX-MM850 (02313URD).....	96
6.5.25 SFP-GE-LX-SM1310 (02313URF).....	97
6.5.26 SFP-GE-SX-C (02314KKF).....	98
6.5.27 SFP-GE-LX-SM1310-BIDI (02314KKJ).....	99
6.5.28 SFP-GE-LX-SM1490-BIDI (02314KKH).....	100
6.6 GE-CWDM eSFP Optical Modules.....	100
6.6.1 CWDM-SFPGE-1471.....	101
6.6.2 CWDM-SFPGE-1491.....	101
6.6.3 CWDM-SFPGE-1511.....	102
6.6.4 CWDM-SFPGE-1531.....	103
6.6.5 CWDM-SFPGE-1551.....	104
6.6.6 CWDM-SFPGE-1571.....	105

---

6.6.7 CWDM-SFPGE-1591.....	105
6.6.8 CWDM-SFPGE-1611.....	106
6.7 GE-DWDM eSFP Optical Modules.....	107
6.7.1 DWDM-SFPGE-1560-61.....	107
6.8 GE SFP Copper Modules.....	108
6.8.1 SFP-1000BaseT (02314171).....	108
6.8.2 SFP-1000BaseT (02313URG).....	109
6.8.3 SFP-GE-TV.....	110

# 1 About This Document

---



## Intended Audience

This document provides an overall description of the switch hardware, helping you obtain detailed information about each chassis and optical module.

This document is intended for network engineers responsible for network design and deployment. You should understand your network well, including the network topology and service requirements.

## Symbol Conventions

The symbols that may be found in this document are defined as follows.

Symbol	Description
	Indicates a potentially hazardous situation which, if not avoided, could result in equipment damage, data loss, performance deterioration, or unanticipated results. NOTICE is used to address practices not related to personal injury.
	Supplements the important information in the main text. NOTE is used to address information not related to personal injury, equipment damage, and environment deterioration.

## Command Conventions

The command conventions that may be found in this document are defined as follows.

Convention	Description
<b>Boldface</b>	The keywords of a command line are in <b>boldface</b> .
<i>Italic</i>	Command arguments are in <i>italics</i> .
[ ]	Items (keywords or arguments) in brackets [ ] are optional.
{ x   y   ... }	Optional items are grouped in braces and separated by vertical bars. One item is selected.
[ x   y   ... ]	Optional items are grouped in brackets and separated by vertical bars. One item is selected or no item is selected.
{ x   y   ... }*	Optional items are grouped in braces and separated by vertical bars. A minimum of one item or a maximum of all items can be selected.
[ x   y   ... ]*	Optional items are grouped in brackets and separated by vertical bars. Several items or no item can be selected.
&<1-n>	The parameter before the & sign can be repeated 1 to n times.
#	A line starting with the # sign is comments.

## Disclaimer

- This document is designed as a reference for you to configure your devices. Its contents, including web pages, command line input and output, are based on laboratory conditions. It provides instructions for general scenarios, but does not cover all use cases of all product models. The examples given may differ from your use case due to differences in software versions, models, and configuration files. When configuring your device, alter the configuration depending on your use case.
- The specifications provided in this document are tested in a lab environment (for example, a certain type of cards have been installed on the tested device or only one protocol is run on the device). Results may differ from the listed specifications when you attempt to obtain the maximum values due to factors such as differences in hardware configurations and carried services.
- In this document, public IP addresses may be used in feature introduction and configuration examples and are for reference only unless otherwise specified.

## Device Dimension Conventions

The dimensions described in this document are theoretically typical dimensions and do not include dimension tolerances.

# 2 Using the Info-Finder

**Info-Finder** is a tool platform, as shown in [Figure 2-1](#). It allows you to search for key product information by product series and model. The key product information includes basic information such as the software specifications, life cycles, and hardware information, and operation and maintenance information such as the licenses, alarms, logs, commands, and MIBs. The hardware-related tools are as follows:

- **Product image gallery:** provides product photos and network element icons for you to produce design drawings and networking diagrams.
- **Hardware configuration:** automatically generates hardware configuration diagrams after you select components are required and calculates the weight, power consumption, and heat consumption.
- **Hardware center:** provides the technical specifications of devices and components, as well as the mapping between devices, components, and versions.
- **3D model:** Using this function, you can query product images, product overview, and component insertion/removal videos, enabling you to quickly obtain product information in one-stop mode.

**Figure 2-1** Info-Finder GUI

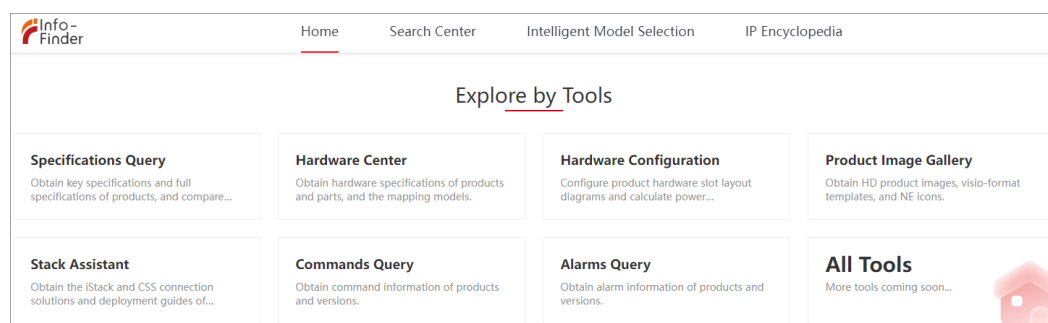

## NOTE

The heat consumption of a device can be calculated as follows based on its power consumption:

$$\text{Heat consumption (BTUs per hour)} = \text{Power consumption (W)} \times 3.4121$$



# 3 Version Requirements for Components

---

This document describes all the device models and modules supported in a version. To obtain accurate subscription information, visit <https://e.huawei.com> or contact Huawei local sales offices. You can also pay attention to the product change notices (PCNs) and lifecycle management bulletins on this website.

The figures in this document are for reference only.

# 4 Chassis

---

[4.1 Chassis Overview](#)

[4.2 Naming Conventions](#)

[4.3 S110](#)

[4.4 S310](#)

## 4.1 Chassis Overview

The S series fixed Ethernet switches integrate the access and transmission functions to provide reliable access/aggregation and high-quality transmission of services on enterprise networks. The switches are built on an integrated hardware platform, and the hardware system consists of the chassis, power module, fan module, and Switch Control Unit (SCU).

## 4.2 Naming Conventions

**Figure 4-1** S110 switch naming conventions

S110-24LP2SR  
— — — — —  
A B C D E F

**Table 4-1** S110 switch naming convention description

Identifier	Description
A	Product series (4 characters) <ul style="list-style-type: none"> <li>• S110: S110 series</li> </ul>
B	Number of downlink ports (1 or 2 characters)
C	Downlink port type (1 or 2 characters) <ul style="list-style-type: none"> <li>• T: GE electrical port</li> <li>• P: GE electrical port, supporting PoE+</li> <li>• LP: GE electrical port, supporting PoE+, low PoE power</li> </ul>
D	Number of uplink ports (1 character)
E	Uplink port type (1 or 2 characters) <ul style="list-style-type: none"> <li>• T: GE electrical port</li> <li>• S: GE optical port</li> <li>• ST: GE optical port and GE electrical port</li> </ul>
F	Special function type (0 or 1 characters) R: the switch can be installed into a rack.

**Figure 4-2** S310 switch naming conventions

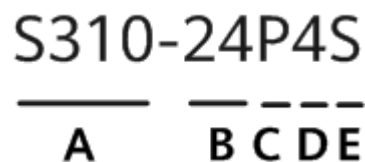

 **NOTE**

The uplink and downlink ports mentioned in this document refer to the recommended usage of the port, and do not indicate that the corresponding port can be used only for the downlink or uplink.

**Table 4-2** S310 switch naming convention description

Identifier	Description
A	Product series (4 characters) <ul style="list-style-type: none"> <li>• S310: S310 series</li> </ul>
B	Number of downlink ports (1 or 2 characters)

Identifier	Description
C	Downlink port type (1 or 2 characters) <ul style="list-style-type: none"> <li>T: GE electrical port</li> <li>P: GE electrical port, supporting PoE+</li> </ul>
D	Number of uplink ports (1 character)
E	Uplink port type (1 or 2 characters) <ul style="list-style-type: none"> <li>T: GE electrical port</li> <li>S: GE optical port</li> <li>ST: GE optical port and GE electrical port</li> </ul>

## 4.3 S110

### 4.3.1 S110-8P2ST (98012195)

#### Overview

Table 4-3 Basic information about the S110-8P2ST

Item	Details
Description	S110-8P2ST (8*10/100/1000BASE-T ports, PoE+, 1*GE SFP port, 1*10/100/1000BASE-T port, AC power, power adapter)
Part Number	98012195
Model	S110-8P2ST

#### Components

Figure 4-3 S110-8P2ST appearance

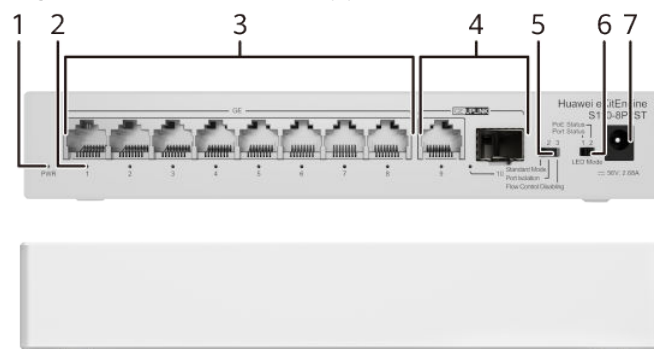

1	PWR indicator	2	Port indicator
3	Eight GE PoE+ electrical ports	4	One GE electrical port and one GE optical port <b>NOTE</b>
5	Port mode switch button <b>NOTE</b> Standard Mode: All ports are in the same VLAN, and the flow control function is enabled. Port Isolation: All downlink ports are isolated from each other and cannot communicate with each other. Downlink ports can communicate only with uplink ports. Uplink ports are not isolated or aggregated. Flow control disabling: All ports are in the same VLAN and flow control is disabled.	6	Port indicator status switch button <b>NOTE</b> Port status: The port indicator indicates the data transmission status of the port. PoE status: The port indicator indicates the PoE status of the port.
7	Power adapter socket <b>NOTE</b> Use the power adapter (56 V 2.68 A) delivered with the device.	-	-

## Ports

**Table 4-4** Ports on the S110-8P2ST

Port	Connector Type	Description	Available Components
GE PoE+ electrical port	RJ45	A GE PoE+ electrical port sends and receives service data at 10/100/1000 Mbit/s. The port supports the PoE function.	<a href="#">Ethernet cable</a>
GE electrical port	RJ45	A GE electrical port sends and receives service data at 10/100/1000 Mbit/s.	<a href="#">Ethernet cable</a>

Port	Connector Type	Description	Available Components
GE optical port	SFP	A GE optical port can send and receive data at 100/1000 Mbit/s.	<ul style="list-style-type: none"> <li>• <b>FE SFP/eSFP optical modules (only optical modules with transmission distances less than or equal to 15 km are supported)</b></li> <li>• <b>GE eSFP optical modules (only optical modules with transmission distances less than or equal to 10 km are supported)</b></li> </ul>

## Indicators and Buttons

**Table 4-5** Description of indicators on the device

Indicator	Color	Status	Description
PWR indicator	-	Off	The device is powered off.
	Green	Steady on	The power supply is normal.
Port indicator (Port status)	-	Off	The port is not connected or has been shut down.
	Green	Steady on	A link has been established on the port. <b>NOTE</b> During device startup, all port indicators are steady green for about 2 seconds and then off, indicating that service initialization is complete.
	Green	Blinking	The port is sending or receiving data.
Port indicator (PoE status)	-	Off	The port is not supplying PoE power.
	Green	Steady on	The port is supplying power to the connected PD.

Indicator	Color	Status	Description
	Green	Blinking	The PoE power of the device is insufficient, and the port cannot provide power to the PD.

## Power Supply System

The device uses the power adapter delivered with the device to supply power to the device and the connected PD. The power adapter can provide 124 W PoE power, which ensures full PoE power on 8 ports in compliance with 802.3af or on 4 ports in compliance with 802.3at.

## Heat Dissipation System

The device has no fans and uses natural heat dissipation.

## Technical Specifications

**Table 4-6** Technical specifications of the S110-8P2ST

Item	Specification
Dimensions without packaging (H x W x D) [mm(in.)]	Basic dimensions (excluding the parts protruding from the body): 35 mm x 210.0 mm x 130.0 mm (1.38 in. x 8.27 in. x 5.12 in.) Maximum dimensions (the depth is the distance from ports on the front panel to the parts protruding from the rear panel): 36.5 mm x 210.0 mm x 131.7 mm (1.44 in. x 8.27 in. x 5.19 in.)
Dimensions with packaging (H x W x D) [mm(in.)]	150.0 mm x 270.0 mm x 200.0 mm (5.91 in. x 10.63 in. x 7.87 in.)
Chassis height [U]	0.8 U
Weight without packaging [kg(lb)]	1.11 kg (2.45 lb)
Weight with packaging [kg(lb)]	1.46 kg (3.22 lb)
Typical power consumption [W]	11 W
Typical heat dissipation [BTU/hour]	37.53 BTU/hour
Maximum power consumption [W]	Without PoE: 11 W Full PoE load: 155 W (PoE: 124 W)
Maximum heat dissipation [BTU/hour]	<ul style="list-style-type: none"> <li>Without PoE: 37.53</li> <li>Full PoE load: 528.88</li> </ul>
Static power consumption [W]	4 W

Item	Specification
MTBF [year]	78.77 year
MTTR [hour]	2 hour
Availability	>0.99999
Noise at normal temperature (acoustic power) [dB(A)]	Noise-free (no fans), < 30
Noise at normal temperature (acoustic pressure) [dB(A)]	Noise-free (no fans), < 20
Number of card slots	0
Number of power slots	0
Number of fans modules	0
Redundant power supply	Not supported
Long-term operating temperature [°C(°F)]	0°C to 40°C (32°F to 104°F) at an altitude of 0-1800 m (0-5906 ft.)
Restriction on the operating temperature variation rate [°C(°F)]	When the altitude is 1800-5000 m (5906-16404 ft.), the highest operating temperature reduces by 1°C (1.8°F) every time the altitude increases by 220 m (722 ft.).
Storage temperature [°C(°F)]	-40°C to +70°C (-40°F to +158°F)
Long-term operating relative humidity [RH]	5% RH to 95% RH (non-condensing)
Long-term operating altitude [m(ft.)]	0-5000 m (0-16404 ft.)
Storage altitude [m(ft.)]	0-5000 m (0-16404 ft.)
Power supply mode	Power adapter
Rated input voltage [V]	Power adapter input: 100-240 V AC; 50/60 Hz Power adapter output: 56 V DC
Input voltage range [V]	Power adapter input: 90 V AC to 264 V AC; 47 Hz to 63 Hz
Maximum input current [A]	2.68 A
Memory	-
Flash memory	-
Console port	Not supported
Eth Management port	Not supported



Item	Specification
USB	Not supported
RTC	Not supported
RPS input	Not supported
Service port surge protection [kV]	Common mode: $\pm 4$ kV
Power supply surge protection [kV]	$\pm 2$ kV in differential mode, $\pm 4$ kV in common mode
Types of fans	None
Heat dissipation mode	Natural heat dissipation
Airflow direction	-
PoE	Supported
Certification	EMC certification Safety certification Manufacturing certification

### 4.3.2 S110-8P2ST (98012269)

#### Overview

**Table 4-7** Basic information about the S110-8P2ST

Item	Details
Description	S110-8P2ST (8*10/100/1000BASE-T ports, PoE+, 1*GE SFP port, 1*10/100/1000BASE-T port, AC power, power adapter)
Part Number	98012269
Model	S110-8P2ST

## Components

Figure 4-4 S110-8P2ST appearance

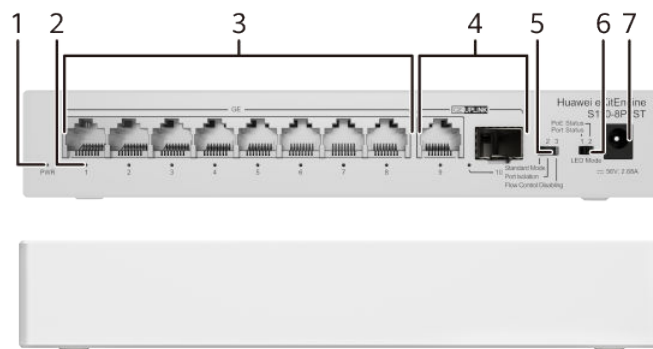

1	PWR indicator	2	Port indicator
3	Eight GE PoE+ electrical ports	4	One GE electrical port and one GE optical port <b>NOTE</b>
5	Port mode switch button <b>NOTE</b> Standard Mode: All ports are in the same VLAN, and the flow control function is enabled. Port Isolation: All downlink ports are isolated from each other and cannot communicate with each other. Downlink ports can communicate only with uplink ports. Uplink ports are not isolated or aggregated. Flow control disabling: All ports are in the same VLAN and flow control is disabled.	6	Port indicator status switch button <b>NOTE</b> Port status: The port indicator indicates the data transmission status of the port. PoE status: The port indicator indicates the PoE status of the port.
7	Power adapter socket <b>NOTE</b> Use the power adapter (56 V 2.68 A) delivered with the device.	-	-

## Ports

**Table 4-8** Ports on the S110-8P2ST

Port	Connector Type	Description	Available Components
GE PoE+ electrical port	RJ45	A GE PoE+ electrical port sends and receives service data at 10/100/1000 Mbit/s. The port supports the PoE function.	<b>Ethernet cable</b>
GE electrical port	RJ45	A GE electrical port sends and receives service data at 10/100/1000 Mbit/s.	<b>Ethernet cable</b>
GE optical port	SFP	A GE optical port can send and receive data at 100/1000 Mbit/s.	<ul style="list-style-type: none"><li>• <b>FE SFP/eSFP optical modules (only optical modules with transmission distances less than or equal to 15 km are supported)</b></li><li>• <b>GE eSFP optical modules (only optical modules with transmission distances less than or equal to 10 km are supported)</b></li></ul>

## Indicators and Buttons

**Table 4-9** Description of indicators on the device

Indicator	Color	Status	Description
PWR indicator	-	Off	The device is powered off.
	Green	Steady on	The power supply is normal.
Port indicator (Port status)	-	Off	The port is not connected or has been shut down.
	Green	Steady on	A link has been established on the port. <b>NOTE</b> During device startup, all port indicators are steady green for about 2 seconds and then off, indicating that service initialization is complete.
	Green	Blinking	The port is sending or receiving data.
Port indicator (PoE status)	-	Off	The port is not supplying PoE power.
	Green	Steady on	The port is supplying power to the connected PD.
	Green	Blinking	The PoE power of the device is insufficient, and the port cannot provide power to the PD.

### Power Supply System

The device uses the power adapter delivered with the device to supply power to the device and the connected PD. The power adapter can provide 124 W PoE power, which ensures full PoE power on 8 ports in compliance with 802.3af or on 4 ports in compliance with 802.3at.

### Heat Dissipation System

The device has no fans and uses natural heat dissipation.

## Technical Specifications

**Table 4-10** Technical specifications of the S110-8P2ST

Item	Specification
Dimensions without packaging (H x W x D) [mm(in.)]	Basic dimensions (excluding the parts protruding from the body): 35 mm x 210.0 mm x 130.0 mm (1.38 in. x 8.27 in. x 5.12 in.) Maximum dimensions (the depth is the distance from ports on the front panel to the parts protruding from the rear panel): 36.5 mm x 210.0 mm x 131.7 mm (1.44 in. x 8.27 in. x 5.19 in.)
Dimensions with packaging (H x W x D) [mm(in.)]	150.0 mm x 270.0 mm x 200.0 mm (5.91 in. x 10.63 in. x 7.87 in.)
Chassis height [U]	0.8 U
Weight without packaging [kg(lb)]	1.11 kg (2.45 lb)
Weight with packaging [kg(lb)]	1.46 kg (3.22 lb)
Typical power consumption [W]	11 W
Typical heat dissipation [BTU/hour]	37.53 BTU/hour
Maximum power consumption [W]	Without PoE: 11 W Full PoE load: 155 W (PoE: 124 W)
Maximum heat dissipation [BTU/hour]	<ul style="list-style-type: none"> <li>• Without PoE: 37.53</li> <li>• Full PoE load: 528.88</li> </ul>
Static power consumption [W]	3 W
MTBF [year]	78.77 year
MTTR [hour]	2 hour
Availability	>0.99999
Noise at normal temperature (acoustic power) [dB(A)]	Noise-free (no fans), < 30
Noise at normal temperature (acoustic pressure) [dB(A)]	Noise-free (no fans), < 20
Number of card slots	0
Number of power slots	0
Number of fans modules	0
Redundant power supply	Not supported

Item	Specification
Long-term operating temperature [°C(°F)]	0°C to 40°C (32°F to 104°F) at an altitude of 0-1800 m (0-5906 ft.)
Restriction on the operating temperature variation rate [°C(°F)]	When the altitude is 1800-5000 m (5906-16404 ft.), the highest operating temperature reduces by 1°C (1.8°F) every time the altitude increases by 220 m (722 ft.).
Storage temperature [°C(°F)]	-40°C to +70°C (-40°F to +158°F)
Long-term operating relative humidity [RH]	5% RH to 95% RH (non-condensing)
Long-term operating altitude [m(ft.)]	0-5000 m (0-16404 ft.)
Storage altitude [m(ft.)]	0-5000 m (0-16404 ft.)
Power supply mode	Power adapter
Rated input voltage [V]	Power adapter input: 170-240 V AC; 50/60 Hz Power adapter output: 56 V DC
Input voltage range [V]	Power adapter input: 170-264 V AC; 47-63 Hz
Maximum input current [A]	2.68 A
Memory	-
Flash memory	-
Console port	Not supported
Eth Management port	Not supported
USB	Not supported
RTC	Not supported
RPS input	Not supported
Service port surge protection [kV]	Common mode: ±4 kV
Power supply surge protection [kV]	Differential mode: ±6 kV; common mode: ±6 kV
Types of fans	None
Heat dissipation mode	Natural heat dissipation
Airflow direction	-
PoE	Supported

Item	Specification
Certification	EMC certification Safety certification Manufacturing certification

### 4.3.3 S110-16LP2SR

#### Overview

**Table 4-11** Basic information about the S110-16LP2SR

Item	Details
Description	S110-16LP2SR (16*10/100/1000BASE-T ports, 2*GE SFP ports, PoE+, AC power)
Part Number	98012197
Model	S110-16LP2SR

#### Components

**Figure 4-5** S110-16LP2SR appearance

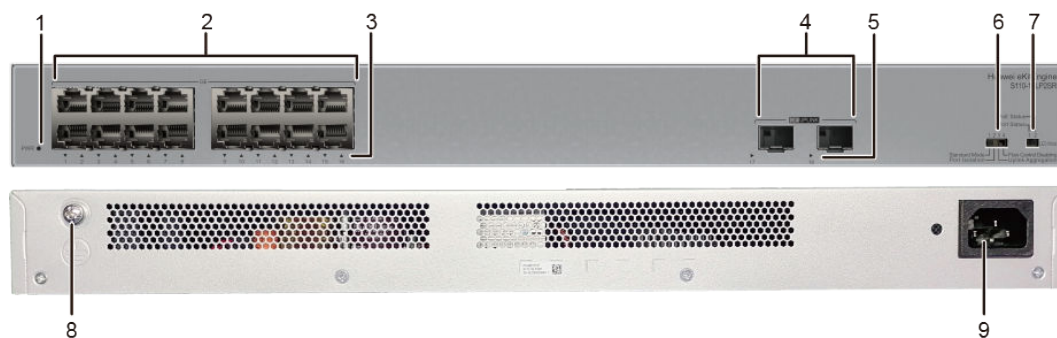

1	PWR indicator	2	Sixteen GE PoE+ electrical ports
3	Electrical port indicator	4	Two GE optical ports

5	Optical port indicator	6	Port mode switch button  <b>NOTE</b> Standard Mode: All ports are in the same VLAN, and the flow control function is enabled. Port Isolation: All downlink ports are isolated from each other and cannot communicate with each other. Downlink ports can communicate only with uplink ports. (The last two downlink electrical ports are not isolated.) Uplink ports are not isolated or aggregated. Uplink Aggregation: Two uplink optical ports are aggregated into a trunk interface. Eth-Trunk supports load balancing only based on source physical ports. Flow control disabling: All ports are in the same VLAN and flow control is disabled.
7	Port indicator status switch button  <b>NOTE</b> Port status: The port indicator indicates the data transmission status of the port. PoE status: The port indicator indicates the PoE status of the port.	8	Ground screw
9	AC socket  <b>NOTE</b> Use the power cable delivered with the device.	-	-

## Ports

**Table 4-12** Ports on the S110-16LP2SR

Port	Connector Type	Description	Available Components
GE PoE+ electrical port	RJ45	A GE PoE+ electrical port sends and receives service data at 10/100/1000 Mbit/s. The port supports the PoE function.	<a href="#">Ethernet cable</a>



Port	Connector Type	Description	Available Components
GE optical port	SFP	A GE optical port can send and receive data at 100/1000 Mbit/s.	<ul style="list-style-type: none"> <li>• <b>FE SFP/eSFP optical modules (only optical modules with transmission distances less than or equal to 15 km are supported)</b></li> <li>• <b>GE eSFP optical modules (only optical modules with transmission distances less than or equal to 10 km are supported)</b></li> </ul>

## Indicators and Buttons

**Table 4-13** Description of indicators on the device

Indicator	Color	Status	Description
PWR indicator	-	Off	The device is powered off.
	Green	Steady on	The power supply is normal.
Port indicator (Port status)	-	Off	The port is not connected or has been shut down.
	Green	Steady on	A link has been established on the port. <b>NOTE</b> During device startup, all port indicators are steady green for about 2 seconds and then off, indicating that service initialization is complete.
	Green	Blinking	The port is sending or receiving data.
Port indicator (PoE status)	-	Off	The port is not supplying PoE power.
	Green	Steady on	The port is supplying power to the connected PD.

Indicator	Color	Status	Description
	Green	Blinking	The PoE power of the device is insufficient, and the port cannot provide power to the PD.

## Power Supply System

The device uses the power adapter delivered with the device to supply power to the device and the connected PD. The power adapter can provide 124 W PoE power, which ensures full PoE power on 8 ports in compliance with 802.3af or on 4 ports in compliance with 802.3at.

## Heat Dissipation System

The device has no fans and uses natural heat dissipation.

## Technical Specifications

**Table 4-14** Technical specifications of the S110-16LP2SR

Item	Specification
Dimensions without packaging (H x W x D) [mm(in.)]	Basic dimensions (excluding the parts protruding from the body): 43.6 mm x 442.0 mm x 260.0 mm (1.72 in. x 17.40 in. x 10.24 in.)  Maximum dimensions (the depth is the distance from ports on the front panel to the parts protruding from the rear panel): 43.6 mm x 442.0 mm x 267.0 mm (1.72 in. x 17.40 in. x 10.51 in.)
Dimensions with packaging (H x W x D) [mm(in.)]	90.0 mm x 555.0 mm x 400.0 mm (3.54 in. x 21.85 in. x 15.75 in.)
Chassis height [U]	1 U
Weight without packaging [kg(lb)]	3.0 kg (6.61 lb)
Weight with packaging [kg(lb)]	3.7 kg (8.16 lb)
Typical power consumption [W]	22.0 W
Typical heat dissipation [BTU/hour]	75.07 BTU/hour
Maximum power consumption [W]	Without PoE: 22.0 W Full PoE load: 160.0 W (PoE: 124 W)
Maximum heat dissipation [BTU/hour]	Without PoE: 75.07 Full PoE load: 545.94

Item	Specification
Static power consumption [W]	12.0 W
MTBF [year]	57.77 year
MTTR [hour]	2 hour
Availability	>0.99999
Noise at normal temperature (acoustic power) [dB(A)]	Noise-free (no fans), < 30
Noise at normal temperature (acoustic pressure) [dB(A)]	Noise-free (no fans), < 20
Number of card slots	0
Number of power slots	0
Number of fans modules	0
Redundant power supply	Not supported
Long-term operating temperature [°C(°F)]	0°C to 40°C (32°F to 104°F) at an altitude of 0-1800 m (0-5906 ft.)
Restriction on the operating temperature variation rate [°C(°F)]	When the altitude is 1800-5000 m (5906-16404 ft.), the highest operating temperature reduces by 1°C (1.8°F) every time the altitude increases by 220 m (722 ft.).
Storage temperature [°C(°F)]	-40°C to +70°C (-40°F to +158°F)
Long-term operating relative humidity [RH]	5% RH to 95% RH (non-condensing)
Long-term operating altitude [m(ft.)]	0-5000 m (0-16404 ft.)
Storage altitude [m(ft.)]	0-5000 m (0-16404 ft.)
Power supply mode	AC built-in
Rated input voltage [V]	AC input: 100-240 V AC; 50/60 Hz
Input voltage range [V]	AC input: 90 V AC to 300 V AC; 47 Hz to 63 Hz
Maximum input current [A]	3 A
Memory	-
Flash memory	-
Console port	Not supported
Eth Management port	Not supported
USB	Not supported

Item	Specification
RTC	Not supported
RPS input	Not supported
Service port surge protection [kV]	Common mode: $\pm 4$ kV
Power supply surge protection [kV]	Differential mode: $\pm 6$ kV; common mode: $\pm 6$ kV
Types of fans	None
Heat dissipation mode	Natural heat dissipation
Airflow direction	-
PoE	Supported
Certification	EMC certification Safety certification Manufacturing certification

### 4.3.4 S110-24T2SR

#### Overview

**Table 4-15** Basic information about the S110-24T2SR

Item	Details
Description	S110-24T2SR (24*10/100/1000BASE-T ports, 2*GE SFP ports, AC power)
Part Number	98012196
Model	S110-24T2SR

#### Components

**Figure 4-6** S110-24T2SR appearance

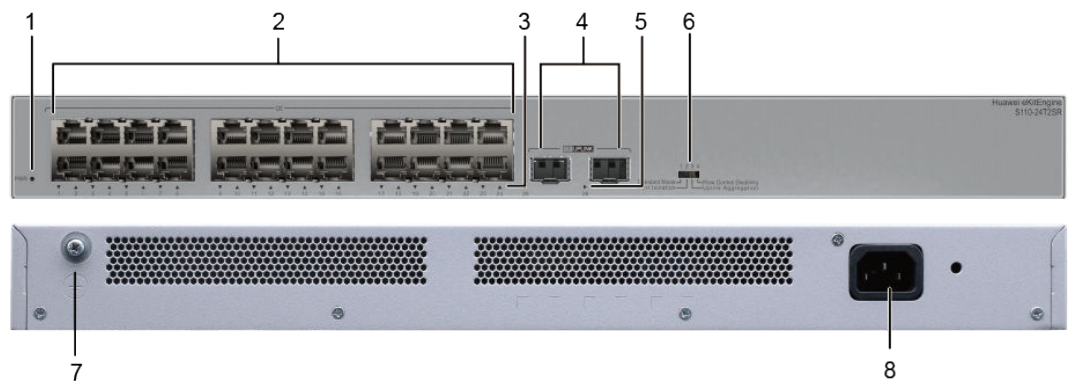

1	PWR indicator	2	Twenty-four GE electrical ports
3	Electrical port indicator	4	Two GE optical ports
5	Optical port indicator	6	Port mode switch button <b>NOTE</b> Standard Mode: All ports are in the same VLAN, and the flow control function is enabled. Port Isolation: All downlink ports are isolated from each other and cannot communicate with each other. Downlink ports can communicate only with uplink ports. (The last two downlink electrical ports are not isolated.) Uplink ports are not isolated or aggregated. Uplink Aggregation: Two uplink optical ports are aggregated into a trunk interface. Eth-Trunk supports load balancing only based on source physical ports. Flow control disabling: All ports are in the same VLAN and flow control is disabled.
7	Ground screw	8	AC socket <b>NOTE</b> Use the power cable delivered with the device.

## Ports

**Table 4-16** Ports on the S110-24T2SR

Port	Connector Type	Description	Available Components
GE PoE+ electrical port	RJ45	A GE PoE+ electrical port sends and receives service data at 10/100/1000 Mbit/s.	<a href="#">Ethernet cable</a>

Port	Connector Type	Description	Available Components
GE optical port	SFP	A GE optical port can send and receive data at 100/1000 Mbit/s.	<ul style="list-style-type: none"><li>• <b>FE SFP/eSFP optical modules (only optical modules with transmission distances less than or equal to 15 km are supported)</b></li><li>• <b>GE eSFP optical modules (only optical modules with transmission distances less than or equal to 10 km are supported)</b></li></ul>

## Indicators and Buttons

Table 4-17 Description of indicators on the device

Indicator	Color	Status	Description
PWR indicator	-	Off	The device is powered off.
	Green	Steady on	The power supply is normal.
Port indicator	-	Off	The port is not connected or has been shut down.
	Green	Steady on	A link has been established on the port. <b>NOTE</b> During device startup, all port indicators are steady green for about 2 seconds and then off, indicating that service initialization is complete.
	Green	Blinking	The port is sending or receiving data.

## Power Supply System

The device is powered by the power cable delivered with the device.

## Heat Dissipation System

The device has no fans and uses natural heat dissipation.

## Technical Specifications

**Table 4-18** Technical specifications of the S110-24T2SR

Item	Specification
Dimensions without packaging (H x W x D) [mm(in.)]	Basic dimensions (excluding the parts protruding from the body): 43.6 mm x 442.0 mm x 160.0 mm (1.72 in. x 17.40 in. x 6.30 in.) Maximum dimensions (the depth is the distance from ports on the front panel to the parts protruding from the rear panel): 43.6 mm x 442.0 mm x 167.0 mm (1.72 in. x 17.40 in. x 6.57 in.)
Dimensions with packaging (H x W x D) [mm(in.)]	90.0 mm x 550.0 mm x 260.0 mm (3.54 in. x 21.65 in. x 10.24 in.)
Chassis height [U]	1 U
Weight without packaging [kg(lb)]	1.8 kg (3.97 lb)
Weight with packaging [kg(lb)]	2.3 kg (5.07 lb)
Typical power consumption [W]	16 W
Typical heat dissipation [BTU/hour]	54.6 BTU/hour
Maximum power consumption [W]	17 W
Maximum heat dissipation [BTU/hour]	58 BTU/hour
Static power consumption [W]	5 W
MTBF [year]	76.10 year
MTTR [hour]	2 hour
Availability	>0.99999
Noise at normal temperature (acoustic power) [dB(A)]	Noise-free (no fans), < 30
Noise at normal temperature (acoustic pressure) [dB(A)]	Noise-free (no fans), < 20
Number of card slots	0
Number of power slots	0
Number of fans modules	0

Item	Specification
Redundant power supply	Not supported
Long-term operating temperature [°C(°F)]	0°C to 40°C (32°F to 104°F) at an altitude of 0-1800 m (0-5906 ft.)
Restriction on the operating temperature variation rate [°C(°F)]	When the altitude is 1800-5000 m (5906-16404 ft.), the highest operating temperature reduces by 1°C (1.8°F) every time the altitude increases by 220 m (722 ft.).
Storage temperature [°C(°F)]	-40°C to +70°C (-40°F to +158°F)
Long-term operating relative humidity [RH]	5% RH to 95% RH (non-condensing)
Long-term operating altitude [m(ft.)]	0-5000 m (0-16404 ft.)
Storage altitude [m(ft.)]	0-5000 m (0-16404 ft.)
Power supply mode	AC built-in
Rated input voltage [V]	AC input: 100-240 V AC; 50/60 Hz
Input voltage range [V]	AC input: 90 V AC to 264 V AC; 45 Hz to 65 Hz
Maximum input current [A]	0.8 A
Memory	-
Flash memory	-
Console port	Not supported
Eth Management port	Not supported
USB	Not supported
RTC	Not supported
RPS input	Not supported
Service port surge protection [kV]	Common mode: ±1 kV
Power supply surge protection [kV]	Differential mode: ±6 kV; common mode: ±6 kV
Types of fans	None
Heat dissipation mode	Natural heat dissipation
Airflow direction	-
PoE	Not supported



Item	Specification
Certification	EMC certification Safety certification Manufacturing certification

### 4.3.5 S110-24LP2SR

#### Overview

**Table 4-19** Basic information about the S110-24LP2SR

Item	Details
Description	S110-24LP2SR (24*10/100/1000BASE-T ports, 2*GE SFP ports, PoE+, AC power)
Part Number	98012198
Model	S110-24LP2SR

#### Components

**Figure 4-7** S110-24LP2SR appearance

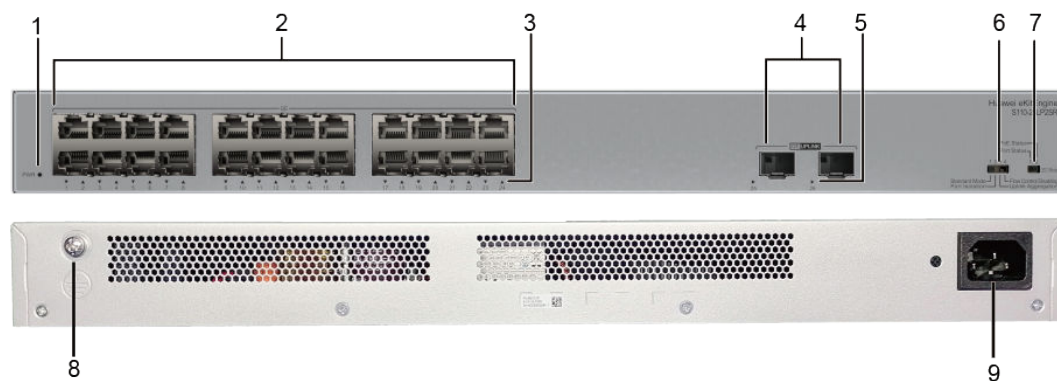

1	PWR indicator	2	Twenty-four GE PoE+ electrical ports
3	Electrical port indicator	4	Two GE optical ports

5	Optical port indicator	6	Port mode switch button  <b>NOTE</b> Standard Mode: All ports are in the same VLAN, and the flow control function is enabled. Port Isolation: All downlink ports are isolated from each other and cannot communicate with each other. Downlink ports can communicate only with uplink ports. (The last two downlink electrical ports are not isolated.) Uplink ports are not isolated or aggregated. Uplink Aggregation: Two uplink optical ports are aggregated into a trunk interface. Eth-Trunk supports load balancing only based on source physical ports. Flow control disabling: All ports are in the same VLAN and flow control is disabled.
7	Port indicator status switch button  <b>NOTE</b> Port status: The port indicator indicates the data transmission status of the port. PoE status: The port indicator indicates the PoE status of the port.	8	Ground screw
9	AC socket  <b>NOTE</b> Use the power cable delivered with the device.	-	-

## Ports

**Table 4-20** Ports on the S110-24LP2SR

Port	Connector Type	Description	Available Components
GE PoE+ electrical port	RJ45	A GE PoE+ electrical port sends and receives service data at 10/100/1000 Mbit/s. The port supports the PoE function.	<a href="#">Ethernet cable</a>

Port	Connector Type	Description	Available Components
GE optical port	SFP	A GE optical port can send and receive data at 100/1000 Mbit/s.	<ul style="list-style-type: none"> <li>• <b>FE SFP/eSFP optical modules (only optical modules with transmission distances less than or equal to 15 km are supported)</b></li> <li>• <b>GE eSFP optical modules (only optical modules with transmission distances less than or equal to 10 km are supported)</b></li> </ul>

## Indicators and Buttons

**Table 4-21** Description of indicators on the device

Indicator	Color	Status	Description
PWR indicator	-	Off	The device is powered off.
	Green	Steady on	The power supply is normal.
Port indicator (Port status)	-	Off	The port is not connected or has been shut down.
	Green	Steady on	A link has been established on the port. <b>NOTE</b> During device startup, all port indicators are steady green for about 2 seconds and then off, indicating that service initialization is complete.
	Green	Blinking	The port is sending or receiving data.
Port indicator (PoE status)	-	Off	The port is not supplying PoE power.
	Green	Steady on	The port is supplying power to the connected PD.

Indicator	Color	Status	Description
	Green	Blinking	The PoE power of the device is insufficient, and the port cannot provide power to the PD.

## Power Supply System

The device uses the power adapter delivered with the device to supply power to the device and the connected PD. The power adapter can provide 124 W PoE power, which ensures full PoE power on 8 ports in compliance with 802.3af or on 4 ports in compliance with 802.3at.

## Heat Dissipation System

The device has no fans and uses natural heat dissipation.

## Technical Specifications

**Table 4-22** Technical specifications of the S110-24LP2SR

Item	Specification
Dimensions without packaging (H x W x D) [mm(in.)]	Basic dimensions (excluding the parts protruding from the body): 43.6 mm x 442.0 mm x 260.0 mm (1.72 in. x 17.40 in. x 10.24 in.)  Maximum dimensions (the depth is the distance from ports on the front panel to the parts protruding from the rear panel): 43.6 mm x 442.0 mm x 267.0 mm (1.72 in. x 17.40 in. x 10.51 in.)
Dimensions with packaging (H x W x D) [mm(in.)]	90.0 mm x 555.0 mm x 400.0 mm (3.54 in. x 21.85 in. x 15.75 in.)
Chassis height [U]	1 U
Weight without packaging [kg(lb)]	3.2 kg (7.05 lb)
Weight with packaging [kg(lb)]	3.7 kg (8.16 lb)
Typical power consumption [W]	24 W
Typical heat dissipation [BTU/hour]	81.89 BTU/hour
Maximum power consumption [W]	Without PoE: 24 W Full PoE load: 165 W (PoE: 124 W)
Maximum heat dissipation [BTU/hour]	Without PoE: 81.89 Full PoE load: 563

Item	Specification
Static power consumption [W]	13 W
MTBF [year]	42.92 year
MTTR [hour]	2 hour
Availability	>0.99999
Noise at normal temperature (acoustic power) [dB(A)]	Noise-free (no fans), < 30
Noise at normal temperature (acoustic pressure) [dB(A)]	Noise-free (no fans), < 20
Number of card slots	0
Number of power slots	0
Number of fans modules	0
Redundant power supply	Not supported
Long-term operating temperature [°C(°F)]	0°C to 40°C (32°F to 104°F) at an altitude of 0-1800 m (0-5906 ft.)
Restriction on the operating temperature variation rate [°C(°F)]	When the altitude is 1800-5000 m (5906-16404 ft.), the highest operating temperature reduces by 1°C (1.8°F) every time the altitude increases by 220 m (722 ft.).
Storage temperature [°C(°F)]	-40°C to +70°C (-40°F to +158°F)
Long-term operating relative humidity [RH]	5% RH to 95% RH (non-condensing)
Long-term operating altitude [m(ft.)]	0-5000 m (0-16404 ft.)
Storage altitude [m(ft.)]	0-5000 m (0-16404 ft.)
Power supply mode	AC built-in
Rated input voltage [V]	AC input: 100-240 V AC; 50/60 Hz
Input voltage range [V]	AC input: 90 V AC to 300 V AC; 47 Hz to 63 Hz
Maximum input current [A]	3 A
Memory	-
Flash memory	-
Console port	Not supported
Eth Management port	Not supported
USB	Not supported

Item	Specification
RTC	Not supported
RPS input	Not supported
Service port surge protection [kV]	Common mode: $\pm 4$ kV
Power supply surge protection [kV]	Differential mode: $\pm 6$ kV; common mode: $\pm 6$ kV
Types of fans	None
Heat dissipation mode	Natural heat dissipation
Airflow direction	-
PoE	Supported
Certification	EMC certification Safety certification Manufacturing certification

## 4.4 S310

### 4.4.1 S310-24T4S

#### Overview

**Table 4-23** Basic information about the S310-24T4S

Item	Details
Description	S310-24T4S(24*10/100/1000BASE-T ports, 4*GE SFP ports, AC power)
Part Number	98012202
Model	S310-24T4S
First supported version	V600R022C10

## Components

Figure 4-8 S310-24T4S appearance

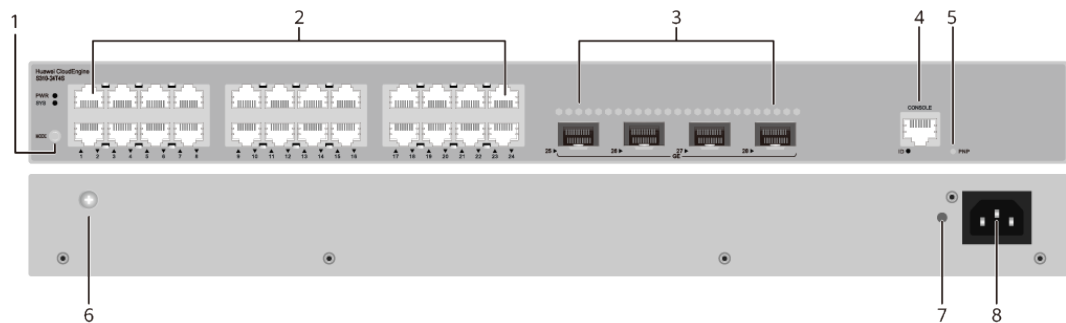

1	<p>One MODE button</p> <p><b>NOTE</b></p> <p>This button is reserved and is not required currently.</p>	2	<p>Twenty-four 10/100/1000BASE-T ports</p>
3	<p>Four 1000BASE-X ports</p>	4	<p>One console port</p>
5	<p>One PNP button</p> <p><b>NOTICE</b></p> <p>To restore the factory settings and reset the switch, hold down the button for at least 6 seconds.</p> <p>To reset the switch, press the button.</p> <p>Resetting the switch will cause service interruption. Exercise caution when you press the PNP button.</p>	6	<p>Ground screw</p> <p><b>NOTE</b></p> <p>It is used with a <a href="#">ground cable</a>.</p>
7	<p>Jack for AC power cable locking strap</p> <p><b>NOTE</b></p> <p>The AC power cable locking strap is not delivered with the switch.</p>	8	<p>AC socket</p> <p><b>NOTE</b></p> <p>It is used with an <a href="#">AC power cable</a>.</p>

## Ports

**Table 4-24** Ports on the S310-24T4S

Port	Connector Type	Description	Available Components
10/100/1000BASE-T port	RJ45	A 10/100/1000BASE-T Ethernet electrical port sends and receives service data at 10/100/1000 Mbit/s.	<a href="#">Ethernet cable</a>
1000BASE-X port	SFP	A 1000BASE-X port can send and receive data at 1000 Mbit/s.	<ul style="list-style-type: none"> <li>• <a href="#">GE eSFP optical modules</a></li> <li>• <a href="#">GE-CWDM eSFP optical modules</a></li> <li>• <a href="#">GE-DWDM eSFP optical modules</a></li> <li>• <a href="#">GE SFP copper module</a></li> </ul>
Console port	RJ45	The console port is connected to a console for on-site configuration.	<a href="#">Console cable</a>

## Indicators and Buttons

The S310-24T4S has similar indicators to those on the S310-24P4S except that the S310-24T4S does not have a PoE mode indicator. For details, see the S310-24P4S.

## Power Supply System

The switch has a built-in AC power module and does not support pluggable power modules.

## Heat Dissipation System

The switch has a built-in fan for forced air cooling. Air flows in from the left side and front panel, and exhausts from the right side.

When working properly at a normal temperature, the device meets the desktop-class noise requirements. However, the fan speed may be high and the noise may be loud during device startup.



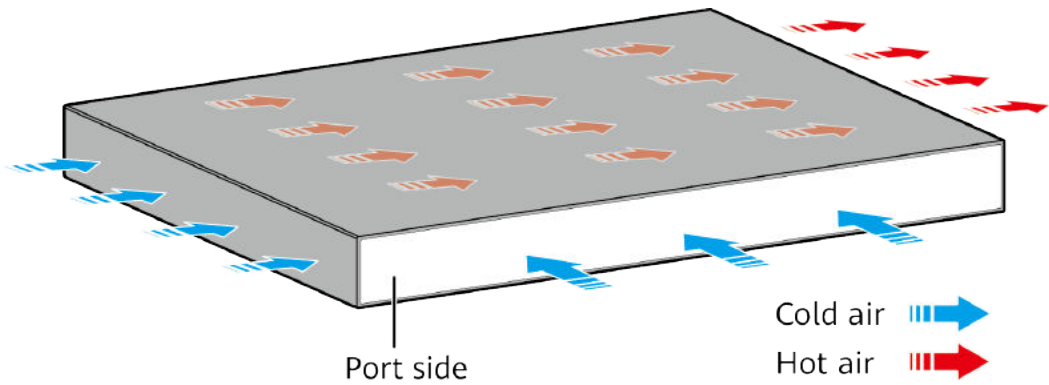

**NOTE**

This figure only shows the airflow direction and does not depict the actual device.

## Technical Specifications

**Table 4-25** Technical specifications of the S310-24T4S

Item	Specification
Dimensions without packaging (H x W x D) [mm(in.)]	Basic dimensions (excluding the parts protruding from the body): 43.6 mm x 442.0 mm x 220.0 mm (1.72 in. x 17.4 in. x 8.66 in.) Maximum dimensions (the depth is the distance from ports on the front panel to the parts protruding from the rear panel): 43.6 mm x 442.0 mm x 227.0 mm (1.72 in. x 17.4 in. x 8.94 in.)
Dimensions with packaging (H x W x D) [mm(in.)]	90.0 mm x 550.0 mm x 360.0 mm (3.54 in. x 21.65 in. x 14.17 in.)
Chassis height [U]	1 U
Weight without packaging [kg(lb)]	2.32 kg (5.11 lb)
Weight with packaging [kg(lb)]	3.44 kg (7.58 lb)
Typical power consumption [W]	26.37 W
Typical heat dissipation [BTU/hour]	89.98 BTU/hour
Maximum power consumption [W]	34.04 W
Maximum heat dissipation [BTU/hour]	116.15 BTU/hour
Static power consumption [W]	19.003 W
MTBF [year]	70.75 year
MTTR [hour]	2 hour
Availability	>0.99999

Item	Specification
Noise at normal temperature (acoustic power) [dB(A)]	47 dB(A)
Noise at normal temperature (acoustic pressure) [dB(A)]	35 dB(A)
Number of card slots	0
Number of power slots	0
Number of fans modules	1
Redundant power supply	Not supported
Long-term operating temperature [°C(°F)]	-5°C to +50°C (23°F to 122°F) at an altitude of 0-1800 m (0-5905.44 ft.)
Restriction on the operating temperature variation rate [°C(°F)]	When the altitude is 1800–5000 m (5906–16404 ft.), the highest operating temperature reduces by 1°C (1.8°F) every time the altitude increases by 220 m (722 ft.). Devices cannot start when the temperature is lower than 0°C (32°F).
Storage temperature [°C(°F)]	-40°C to +70°C (-40°F to +158°F)
Long-term operating relative humidity [RH]	5% RH to 95% RH (non-condensing)
Long-term operating altitude [m(ft.)]	0–5000 m (0–16404 ft.)
Storage altitude [m(ft.)]	0–5000 m (0–16404 ft.)
Power supply mode	AC built-in
Rated input voltage [V]	AC input: 100–240 V AC; 50/60 Hz
Input voltage range [V]	AC input: 90–290 V AC; 45–65 Hz
Maximum input current [A]	0.8 A
Memory	2 GB
Flash memory	1 GB in total. To view the available flash memory size, run the display version command.
Console port	RJ45
Eth Management port	Not supported
USB	Not supported
RTC	Not supported
RPS input	Not supported

Item	Specification
Service port surge protection [kV]	Common mode: $\pm 7$ kV
Power supply surge protection [kV]	Differential mode: $\pm 6$ kV; common mode: $\pm 6$ kV
Types of fans	Built-in
Heat dissipation mode	Air cooling for heat dissipation, intelligent fan speed adjustment
Airflow direction	Air intake from left and front, air exhaustion from right
PoE	Not supported
Certification	EMC certification Safety certification Manufacturing certification

## 4.4.2 S310-24P4S

### Overview

**Table 4-26** Basic information about the S310-24P4S

Item	Details
Description	S310-24P4S (24*10/100/1000BASE-T ports, 4*GE SFP ports, PoE+, AC power)
Part Number	98012201
Model	S310-24P4S
First supported version	V600R022C10

### Components

**Figure 4-9** S310-24P4S appearance

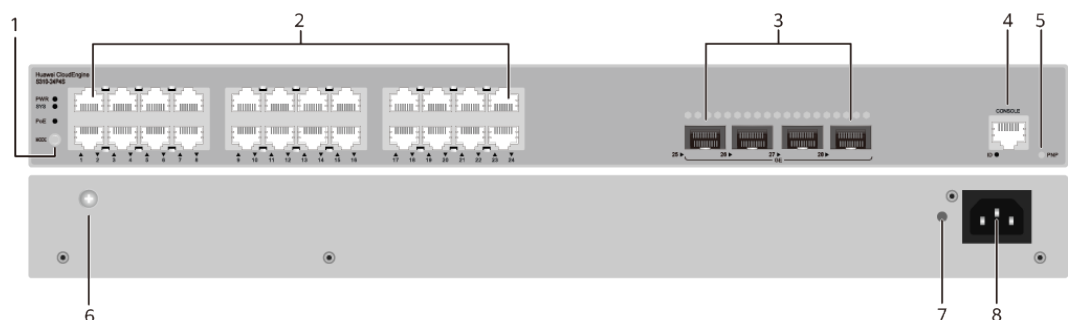

1	One MODE button	2	Twenty-four 10/100/1000BASE-T PoE+ ports
3	Four 1000BASE-X ports	4	One console port
5	One PNP button <b>NOTICE</b> To restore the factory settings and reset the switch, hold down the button for at least 6 seconds. To reset the switch, press the button. Resetting the switch will cause service interruption. Exercise caution when you press the PNP button.	6	Ground screw <b>NOTE</b> It is used with a <a href="#">ground cable</a> .
7	Jack for AC power cable locking strap <b>NOTE</b> The AC power cable locking strap is not delivered with the switch.	8	AC socket <b>NOTE</b> It is used with an <a href="#">AC power cable</a> .

## Ports

**Table 4-27** Ports on the S310-24P4S

Port	Connector Type	Description	Available Components
10/100/1000BASE-T PoE+ port	RJ45	A 10/100/1000BASE-T PoE+ Ethernet electrical port sends and receives service data at 10/100/1000 Mbit/s. The port supports the PoE function.	<a href="#">Ethernet cable</a>

Port	Connector Type	Description	Available Components
1000BASE-X port	SFP	A 1000BASE-X port can send and receive data at 1000 Mbit/s.	<ul style="list-style-type: none"> <li>• <b>GE eSFP optical modules</b></li> <li>• <b>GE-CWDM eSFP optical modules</b></li> <li>• <b>GE-DWDM eSFP optical modules</b></li> <li>• <b>GE SFP copper module</b></li> </ul>
Console port	RJ45	The console port is connected to a console for on-site configuration.	<b>Console cable</b>

## Indicators and Buttons

Figure 4-10 Indicators on the Switch

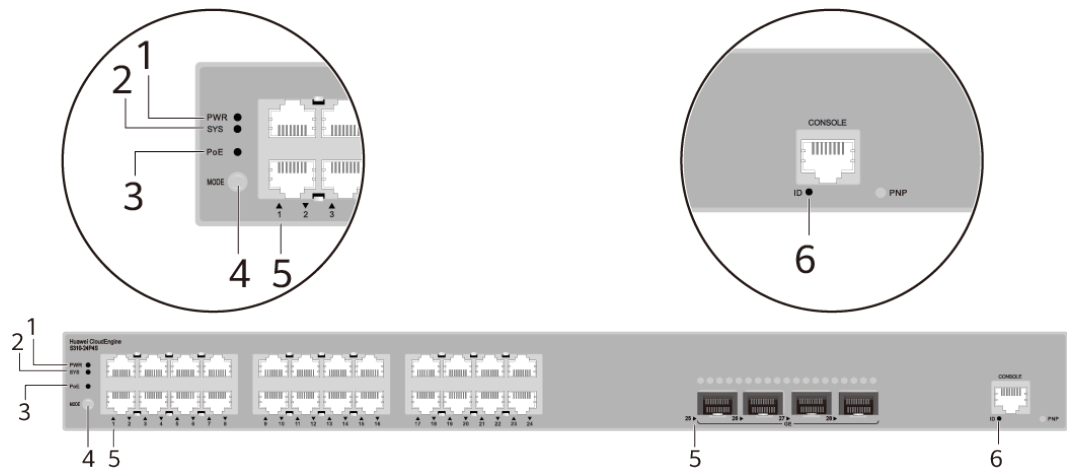

Table 4-28 Description of indicators on the switch

No.	Indicator	Name	Color	Status	Description
1	PWR	Power module indicator	-	Off	The switch is powered off.
			Green	Steady on	The power supply is normal.
			Yellow	Steady on	The power supply is abnormal.

No.	Indicator	Name	Color	Status	Description
2	SYS	System status indicator	-	Off	The system is not running.
			Green	Fast blinking	The system is starting.
			Green	Steady on	During the system startup preparation phase, the SYS indicator is steady green, which lasts for a maximum of 30 seconds.
			Green	Slow blinking	The system is running normally.
			Red	Steady on	The system does not work normally after registration, or a fan alarm or a temperature alarm has been generated.
3	PoE	PoE indicator	-	Off	The PoE mode is not selected.
			Green	Steady on	The PoE mode is selected, and service port indicators show the PoE status of each port.
4	MODE	Mode switch button	-	-	<ul style="list-style-type: none"> <li>When you press this button once, the service port indicators change to the PoE mode and show the PoE status of each service port.</li> <li>When you press this button a second time, the service port indicators restore to the default mode and show the connection status and link activity of each service port.</li> </ul> <p>If you do not press the MODE button within 45 seconds, the service port indicators restore to the default mode. In this case, the PoE indicator is off.</p>
5	-	Service port indicator	Meanings of service port indicators vary in different modes. For details, see <a href="#">Table 4-29</a> . <b>NOTE</b> If a power failure occurs on a device's PCB board, indicators of the last four optical ports on the device's front panel blink green cyclically at an interval of 1 second, with each indicator illuminating for 0.25 seconds.		
6	ID	ID indicator	-	Off	The ID indicator is not used (default state).

No.	Indicator	Name	Color	Status	Description
			Blue	Steady on	The indicator identifies the switch to maintain. The ID indicator can be turned on or off remotely to help field engineers find the switch to maintain.

**Table 4-29** Description of service port indicators in different modes (one indicator for each port)

Display Mode	Color	Status	Description
Default mode	-	Off	The port is not connected or has been shut down.
	Green	Steady on	A link has been established on the port.
	Green	Blinking	The port is sending or receiving data.
PoE mode	-	Off	The port is not providing power to a powered device (PD).
	Green	Steady on	The port is providing power to a PD.
	Green	Blinking	The power of the PD connected to the port exceeds the power capacity of the port or the power threshold configured on the port. Alternatively, the PD does not comply with IEEE standards.

## Power Supply System

The switch has a built-in AC power module and does not support pluggable power modules. The built-in power module can provide 400 W PoE power, which ensures full PoE power on 24 ports in compliance with 802.3af or on 13 ports in compliance with 802.3at.

## Heat Dissipation System

The switch has two built-in fans for forced air cooling. Air flows in from the left side and front panel, and exhausts from the right side.

When working properly at a normal temperature, the device meets the desktop-class noise requirements. However, the fan speed may be high and the noise may be loud during device startup.

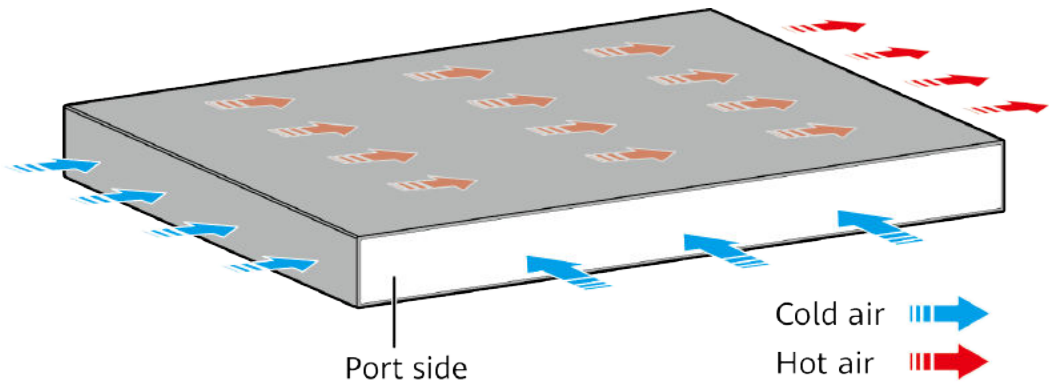

**NOTE**

This figure only shows the airflow direction and does not depict the actual device.

## Technical Specifications

**Table 4-30** Technical specifications of the S310-24P4S

Item	Specification
Dimensions without packaging (H x W x D) [mm(in.)]	Basic dimensions (excluding the parts protruding from the body): 43.6 mm x 442.0 mm x 220.0 mm (1.72 in. x 17.4 in. x 8.66 in.) Maximum dimensions (the depth is the distance from ports on the front panel to the parts protruding from the rear panel): 43.6 mm x 442.0 mm x 227.0 mm (1.72 in. x 17.4 in. x 8.94 in.)
Dimensions with packaging (H x W x D) [mm(in.)]	90.0 mm x 550.0 mm x 360.0 mm (3.54 in. x 21.65 in. x 14.17 in.)
Chassis height [U]	1 U
Weight without packaging [kg(lb)]	2.92 kg (6.44 lb)
Weight with packaging [kg(lb)]	3.79 kg (8.36 lb)
Typical power consumption [W]	40.07 W
Typical heat dissipation [BTU/hour]	136.72 BTU/hour
Maximum power consumption [W]	<ul style="list-style-type: none"> <li>Without PoE: 47.1 W</li> <li>Full PoE load: 491.66 W (PoE: 400 W)</li> </ul>
Maximum heat dissipation [BTU/hour]	<ul style="list-style-type: none"> <li>Without PoE: 160.71</li> <li>Full PoE load: 1677.59</li> </ul>
Static power consumption [W]	30.82 W



Item	Specification
MTBF [year]	60.18 year
MTTR [hour]	2 hour
Availability	>0.99999
Noise at normal temperature (acoustic power) [dB(A)]	49.3 dB(A)
Noise at normal temperature (acoustic pressure) [dB(A)]	37.3 dB(A)
Number of card slots	0
Number of power slots	0
Number of fans modules	2
Redundant power supply	Not supported
Long-term operating temperature [°C(°F)]	-5°C to +50°C (23°F to 122°F) at an altitude of 0-1800 m (0-5905.44 ft.)
Restriction on the operating temperature variation rate [°C(°F)]	When the altitude is 1800–5000 m (5906–16404 ft.), the highest operating temperature reduces by 1°C (1.8°F) every time the altitude increases by 220 m (722 ft.). Devices cannot start when the temperature is lower than 0°C (32°F).
Storage temperature [°C(°F)]	-40°C to +70°C (-40°F to +158°F)
Long-term operating relative humidity [RH]	5% RH to 95% RH (non-condensing)
Long-term operating altitude [m(ft.)]	0–5000 m (0–16404 ft.)
Storage altitude [m(ft.)]	0–5000 m (0–16404 ft.)
Power supply mode	AC built-in
Rated input voltage [V]	AC input: 100–240 V AC; 50/60 Hz
Input voltage range [V]	AC input: 90–290 V AC; 45–65 Hz
Maximum input current [A]	6 A
Memory	2 GB
Flash memory	1 GB in total. To view the available flash memory size, run the display version command.
Console port	RJ45
Eth Management port	Not supported

Item	Specification
USB	Not supported
RTC	Not supported
RPS input	Not supported
Service port surge protection [kV]	Common mode: $\pm 7$ kV
Power supply surge protection [kV]	Differential mode: $\pm 6$ kV; common mode: $\pm 6$ kV
Types of fans	Built-in
Heat dissipation mode	Air cooling for heat dissipation, intelligent fan speed adjustment
Airflow direction	Air intake from left and front, air exhaustion from right
PoE	Supported
Certification	EMC certification Safety certification Manufacturing certification

### 4.4.3 S310-48T4S

#### Overview

**Table 4-31** Basic information about the S310-48T4S

Item	Details
Description	S310-48T4S(48*10/100/1000BASE-T ports, 4*GE SFP ports, AC power)
Part Number	98012203
Model	S310-48T4S
First supported version	V600R022C10

## Components

Figure 4-11 S310-48T4S appearance

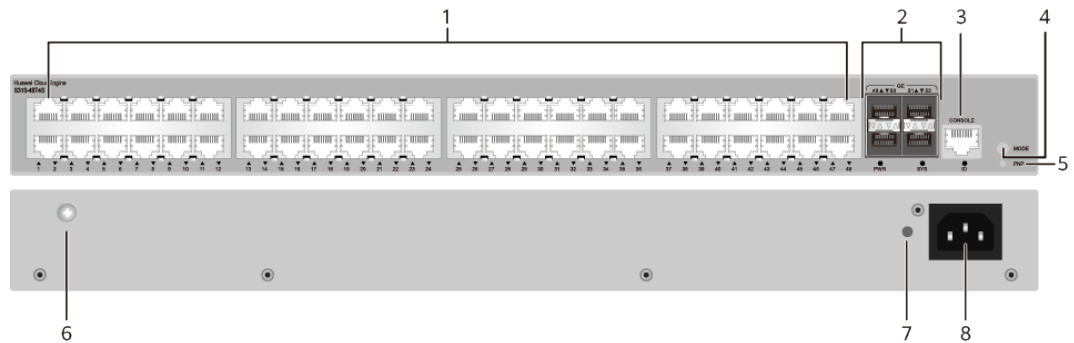

1	Forty-eight 10/100/1000BASE-T ports	2	Four 1000BASE-X ports
3	One console port	4	One MODE button <b>NOTE</b> This button is reserved and is not required currently.
5	One PNP button <b>NOTICE</b> To restore the factory settings and reset the switch, hold down the button for at least 6 seconds. To reset the switch, press the button. Resetting the switch will cause service interruption. Exercise caution when you press the PNP button.	6	Ground screw <b>NOTE</b> It is used with a <a href="#">ground cable</a> .
7	Jack for AC power cable locking strap <b>NOTE</b> The AC power cable locking strap is not delivered with the switch.	8	AC socket <b>NOTE</b> It is used with an <a href="#">AC power cable</a> .

## Ports

**Table 4-32** Ports on the S310-48T4S

Port	Connector Type	Description	Available Components
10/100/1000BASE-T port	RJ45	A 10/100/1000BASE-T Ethernet electrical port sends and receives service data at 10/100/1000 Mbit/s.	<a href="#">Ethernet cable</a>
1000BASE-X port	SFP	A 1000BASE-X port can send and receive data at 1000 Mbit/s.	<ul style="list-style-type: none"> <li>• <a href="#">GE eSFP optical modules</a></li> <li>• <a href="#">GE-CWDM eSFP optical modules</a></li> <li>• <a href="#">GE-DWDM eSFP optical modules</a></li> <li>• <a href="#">GE SFP copper module</a></li> </ul>
Console port	RJ45	The console port is connected to a console for on-site configuration.	<a href="#">Console cable</a>

## Indicators and Buttons

The S310-48T4S has similar indicators to those on the S310-24P4S except that the S310-48T4S does not have a PoE mode indicator. For details, see the S310-24P4S.

## Power Supply System

The switch has a built-in AC power module and does not support pluggable power modules.

## Heat Dissipation System

The switch has a built-in fan for forced air cooling. Air flows in from the left side, and exhausts from the right side.

When working properly at a normal temperature, the device meets the desktop-class noise requirements. However, the fan speed may be high and the noise may be loud during device startup.

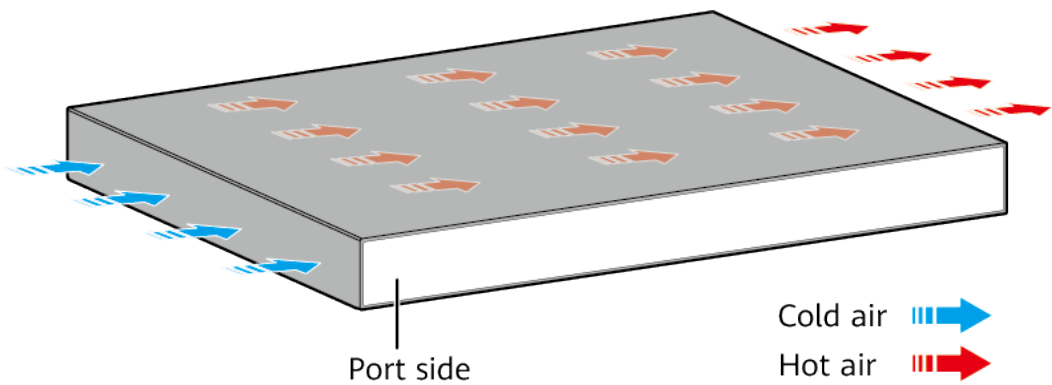

**NOTE**

This figure only shows the airflow direction and does not depict the actual device.

## Technical Specifications

**Table 4-33** Technical specifications of the S310-48T4S

Item	Specification
Dimensions without packaging (H x W x D) [mm(in.)]	Basic dimensions (excluding the parts protruding from the body): 43.6 mm x 442.0 mm x 220.0 mm (1.72 in. x 17.4 in. x 8.66 in.)  Maximum dimensions (the depth is the distance from ports on the front panel to the parts protruding from the rear panel): 43.6 mm x 442.0 mm x 227.0 mm (1.72 in. x 17.4 in. x 8.94 in.)
Dimensions with packaging (H x W x D) [mm(in.)]	90.0 mm x 550.0 mm x 360.0 mm (3.54 in. x 21.65 in. x 14.17 in.)
Chassis height [U]	1 U
Weight without packaging [kg(lb)]	2.71 kg (5.97 lb)
Weight with packaging [kg(lb)]	3.59 kg (7.91 lb)
Typical power consumption [W]	44.9 W
Typical heat dissipation [BTU/hour]	153.2 BTU/hour
Maximum power consumption [W]	52.05 W
Maximum heat dissipation [BTU/hour]	177.6 BTU/hour
Static power consumption [W]	27.55 W
MTBF [year]	40.61 year
MTTR [hour]	2 hour
Availability	>0.99999

Item	Specification
Noise at normal temperature (acoustic power) [dB(A)]	46.6 dB(A)
Noise at normal temperature (acoustic pressure) [dB(A)]	34.6 dB(A)
Number of card slots	0
Number of power slots	0
Number of fans modules	1
Redundant power supply	Not supported
Long-term operating temperature [°C(°F)]	-5°C to +50°C (23°F to 122°F) at an altitude of 0-1800 m (0-5905.44 ft.)
Restriction on the operating temperature variation rate [°C(°F)]	When the altitude is 1800–5000 m (5906–16404 ft.), the highest operating temperature reduces by 1°C (1.8°F) every time the altitude increases by 220 m (722 ft.). Devices cannot start when the temperature is lower than 0°C (32°F). The operating temperature ranges from -5°C (23°F) to +45°C (113°F) when optical modules with transmission distances greater than or equal to 60 km are used.
Storage temperature [°C(°F)]	-40°C to +70°C (-40°F to +158°F)
Long-term operating relative humidity [RH]	5% RH to 95% RH (non-condensing)
Long-term operating altitude [m(ft.)]	0-5000 m (0-16404 ft.)
Storage altitude [m(ft.)]	0-5000 m (0-16404 ft.)
Power supply mode	AC built-in
Rated input voltage [V]	AC input: 100–240 V AC; 50/60 Hz
Input voltage range [V]	AC input: 90–290 V AC; 45–65 Hz
Maximum input current [A]	1.6 A
Memory	2 GB
Flash memory	1 GB in total. To view the available flash memory size, run the display version command.
Console port	RJ45
Eth Management port	Not supported

Item	Specification
USB	Not supported
RTC	Not supported
RPS input	Not supported
Service port surge protection [kV]	Common mode: $\pm 7$ kV
Power supply surge protection [kV]	Differential mode: $\pm 6$ kV; common mode: $\pm 6$ kV
Types of fans	Built-in
Heat dissipation mode	Air cooling for heat dissipation, intelligent fan speed adjustment
Airflow direction	Air intake from left and air exhaust from right
PoE	Not supported
Certification	EMC certification Safety certification Manufacturing certification

# 5 Cables

---

- [5.1 Ground Cable](#)
- [5.2 Optical Fiber](#)
- [5.3 Ethernet Cable](#)
- [5.4 AC Power Cable](#)
- [5.5 Console Cable](#)

## 5.1 Ground Cable

### Appearance and Structure

**Figure 5-1** shows the appearance of a typical ground cable.

 **NOTE**

Other types of ground cables are similar to the example shown in the figure, except for their cross-sectional area, size of the cable lugs, and cable length.

**Figure 5-1** Appearance of a ground cable





Figure 5-2 shows the structure of a ground cable.

Figure 5-2 Structure of a ground cable

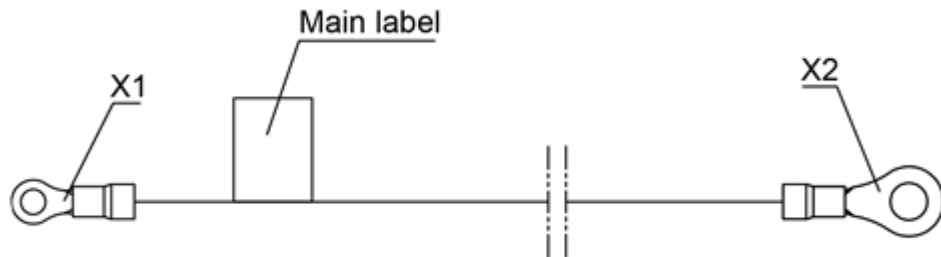

## Pin Assignments

Table 5-1 lists the pin assignments of a ground cable.

Table 5-1 Pin assignments of a ground cable

X1	X2	Wire Color	Conductor Cross-Sectional Area	Length
OT-4	OT-6	Green-yellow	4 mm <sup>2</sup>	0.4 m

## Connection

A ground cable grounds a device to protect it from lightning and electromagnetic interference. A ground cable is connected to a chassis in the following way:

- The OT-4 naked crimping connector connects to the ground point on the chassis.
- The OT-6 naked crimping connector connects to the ground point on the cabinet.

## 5.2 Optical Fiber

### Fiber Jumper

A fiber jumper consists of one or more fibers of a certain length and the optical connectors at both ends. A fiber jumper connects an optical module to a fiber terminal box.

Figure 5-3 shows a single-mode LC/PC fiber jumper.

**Figure 5-3** Single-mode LC/PC fiber jumper

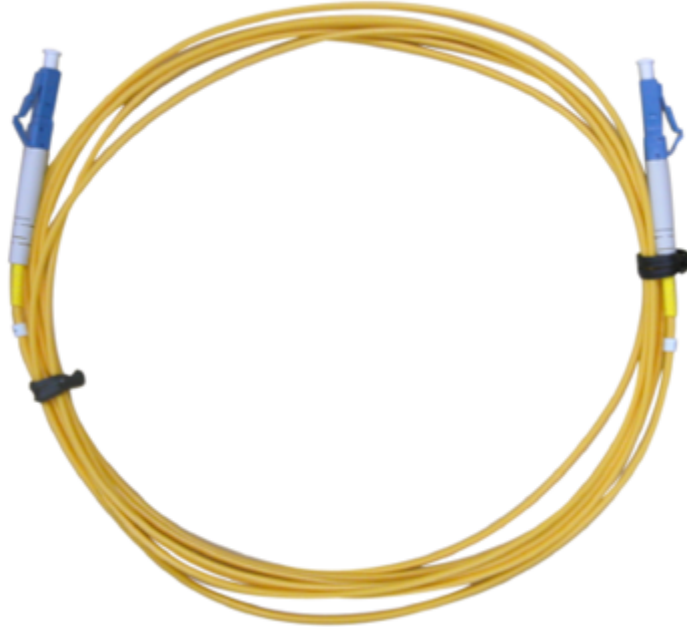

**Figure 5-4** shows a multimode LC/PC fiber jumper.

**Figure 5-4** Multimode LC/PC fiber jumper



**Figure 5-5** shows a single-mode SC/PC fiber jumper.

**Figure 5-5** Single-mode SC/PC fiber jumper



Comply with the following rules when selecting fiber jumpers:

1. Determine the length of fiber jumpers based on the onsite cabling distance.
2. Determine the fiber type based on the optical module type.
  - Use a multimode fiber jumper for a multimode optical module.
  - Use a single-mode fiber jumper for a single-mode optical module.
3. Determine the optical connector type based on the interface type.

Ensure that the optical connector at each end of a fiber jumper is the same type as the interface to which it will be connected.

## Fiber Pigtail

A fiber pigtail is an optical fiber that has an optical connector on one end and a piece of exposed fiber at the other end. The exposed fiber can be fused to another optical fiber. Fiber pigtails are commonly used to connect optical fibers to optical modules in fiber terminal boxes (couplers and jumpers are also used). [Figure 5-6](#) shows the structure of a fiber pigtail.

**Figure 5-6** Structure of a fiber pigtail

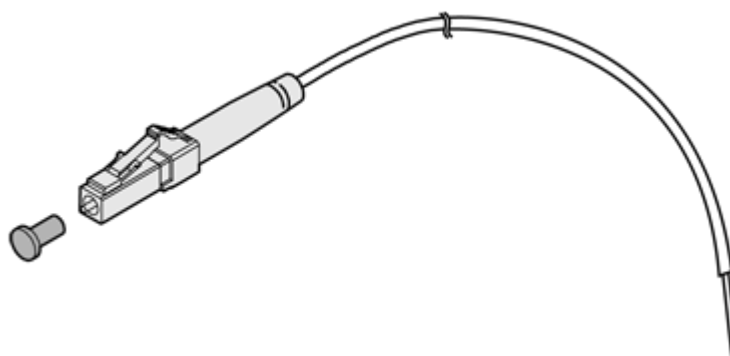

Fiber pigtails are classified into single-mode and multimode fiber pigtails and are used for short-distance connections.

## Optical Fiber, Optical Connector, and Fiber Adapter

### Optical Fibers

Optical fibers are classified into single-mode fibers and multimode fibers.

- Single-mode fibers have a diameter of 5-10  $\mu\text{m}$  and transmit laser in one mode under a specified wavelength. These fibers support a wide frequency band and a large transmission capacity, so they are used for long-distance transmission. Most single-mode fibers are yellow, as shown in [Figure 5-3](#).
- Multimode fibers have a diameter of 50  $\mu\text{m}$  or 62.5  $\mu\text{m}$  and transmit laser light in multiple modes under a specified wavelength. These fibers have a lower transmission capacity than single-mode fibers and are used for short-distance transmission. Modal dispersion occurs during transmission over multimode fibers.





In the latest cabling infrastructure of ISO/IEC 11801, multimode fibers are classified into four categories: OM1, OM2, OM3, and OM4.

- OM1: traditional 62.5/125  $\mu\text{m}$  multimode fibers. OM1 fibers have a large core diameter and numerical aperture, and provide high light gathering ability and bending resistance.
- OM2: traditional 50/125  $\mu\text{m}$  multimode fibers. OM2 fibers have a small core diameter and numerical aperture. Compared with OM1 fibers, OM2 fibers provide higher bandwidth because they significantly reduce the modal dispersion. When transmitting data at 1 Gbit/s with 850 nm wavelength, OM1 and OM2 fibers support maximum link lengths of 220 m and 550 m, respectively. OM1 and OM2 fibers can provide sufficient bandwidth within a distance of 300 m. Generally, OM1 and OM2 fibers are orange, as shown in [Figure 5-4](#).
- OM3: new-generation multimode fibers, with longer transmission distances than OM1 and OM2 fibers.
- OM4: laser optimized multimode fibers with 50  $\mu\text{m}$  core diameter. OM4 is an improvement to OM3 and only increases the modal bandwidth. OM4 fibers provide 4700 MHz\*km of modal bandwidth, whereas OM3 fibers provide only 2000 MHz\*km of modal bandwidth. Generally, OM3 and OM4 fibers are light green. You can identify OM3 and OM4 fibers by their labels or printed marks.

### Optical Connector

Optical connectors are used to connect optical fibers of the same type. [Table 5-2](#) lists common optical connectors.

**Table 5-2** Common optical connectors

Connect or Type	Optical Connector			
Square connector	SC/PC connector 	LC/PC connector 	MTRJ/PC connector 	MPO connector 



Connect or Type	Optical Connector			
Round connector	FC/PC connector 	ST/PC connector 	-	-

Figure 5-7 shows an LC/PC optical connector.

Figure 5-7 LC/PC optical connector

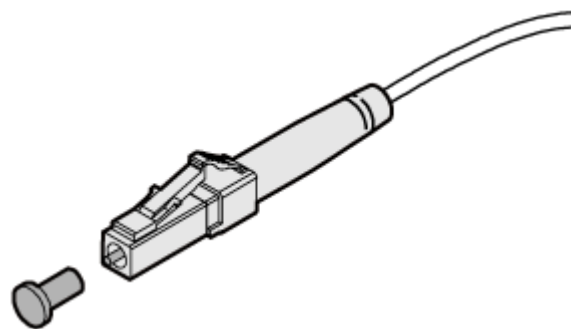

#### NOTICE

When connecting or removing an LC/PC optical connector, align the connector with the optical port and do not rotate the fiber. Pay attention to the following points:

- To connect a fiber, align the optical connector with the optical port and gently insert the optical fiber into the port.
- To remove a fiber, press the clip on the connector and pull the fiber out.

#### Fiber Adapter

A fiber adapter (also called a flange) is a fiber connection component. Two fiber connectors need to be connected using a fiber adapter. Fiber adapters are widely used in optical distribution frames (ODFs), fiber transmission equipment, and optical instruments.

## 5.3 Ethernet Cable

### Types of Ethernet Cables

An Ethernet cable connects a maintenance terminal to the console port on the device for local or remote maintenance.

Ethernet cables are classified into straight-through cables and crossover cables.

- Straight-through cable: The twisted pairs in the RJ45 connectors at both ends are crimped in the same sequence. A straight-through cable connects two devices of different types, for example, a PC and a switch.
- Crossover cable: The twisted pairs in the RJ45 connectors at two ends are crimped in different sequences. A crossover cable connects two devices or interfaces of the same type, for example, two PCs.

Crossover and straight cables only differ in wire sequences, and function the same when transmitting data.

Huawei S series models support both straight-through and crossover cables and their ports are adaptive to the cable types.

Use shielded Ethernet cables when devices complying with EN 50121-4 are used in environments that meet EN 50121-4 requirements.

## Appearance and Structure

### NOTE

The straight-through cable and the crossover cable have the same appearance and use the RJ45 connector.

**Figure 5-8** shows the appearance of an Ethernet cable.

**Figure 5-8** Appearance of an Ethernet cable



**Figure 5-9** shows the structure of an Ethernet cable.

**Figure 5-9** Structure of an Ethernet cable

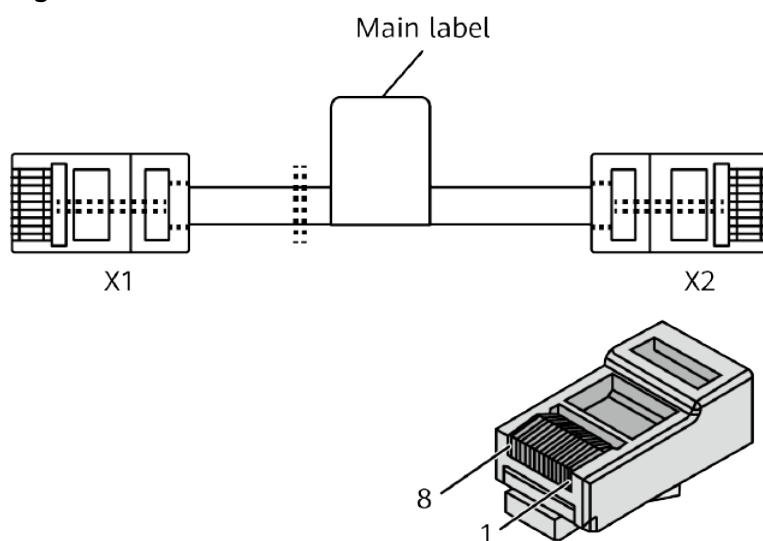

## Pin Assignments

**Table 5-3** lists pin assignments of a straight-through cable.

**Table 5-3** Pin assignments of a straight-through cable

Connector X1	Connector X2	Color	Relationship
X1.2	X2.2	Orange	Twisted pair
X1.1	X2.1	White/Orange	
X1.6	X2.6	Green	Twisted pair
X1.3	X2.3	White/Green	
X1.4	X2.4	Blue	Twisted pair
X1.5	X2.5	White/Blue	
X1.8	X2.8	Brown	Twisted pair
X1.7	X2.7	White/Brown	

**Table 5-4** lists pin assignments of a crossover cable.

**Table 5-4** Pin assignments of a crossover cable

Connector X1	Connector X2	Color	Relationship
X1.6	X2.2	Orange	Twisted pair
X1.3	X2.1	White/Orange	
X1.2	X2.6	Green	Twisted pair
X1.1	X2.3	White/Green	
X1.4	X2.4	Blue	Twisted pair
X1.5	X2.5	White/Blue	
X1.8	X2.8	Brown	Twisted pair
X1.7	X2.7	White/Brown	

**NOTE**

To achieve the best electrical transmission performance, ensure that the wires connected to pins 1 and 2 and to pins 3 and 6 are twisted pairs.

## 5.4 AC Power Cable

### Appearance and Structure

**Figure 5-10** C13 straight female to PI straight male AC power cable (used in China)



**Figure 5-11** C13 straight female to C14 straight male AC power cable (China)



**Figure 5-12** Appearance of a power adapter



**NOTE**

The AC power cables used in different countries and regions have different connector types. [Figure 5-10](#) use Chinese AC power cables as examples. The power cable and plug delivered with the chassis can only be used on this chassis, and cannot be used on other devices.

## Types of AC Power Cables

Select AC power cables based on the power supply system in your equipment room. Standard and country-specific AC power cables can be directly connected to power modules.

- Standard power cables: used to transmit power from a PDU. [Figure 5-13](#) shows the structure of a C14 straight male to C13 straight female AC power cable.
- Country-specific power cables: used to transmit power from a country-specific power strip. The cables are delivered in compliance with standards of the destination country or region. For example, PI straight male to C13 straight female AC power cable ([Figure 5-14](#)) is used in China.

- The AC power cables connected to a power distribution box must have cord end terminals. **Figure 5-15** shows the structure of a cord end to C13 straight female AC power cable.

**Figure 5-13** Structure of a C14 straight male to C13 straight female AC power cable

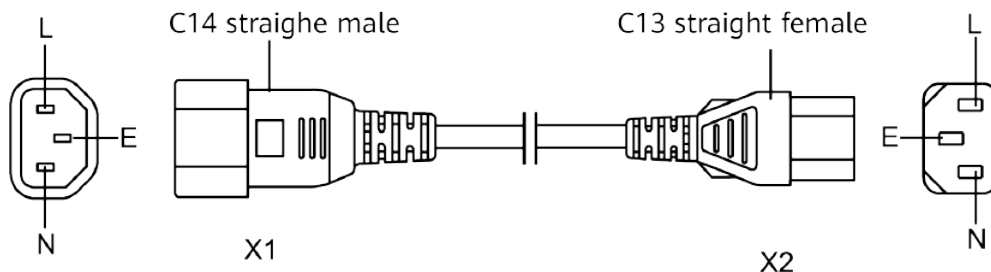

**Figure 5-14** Structure of a PI straight male to C13 straight female AC power cable (used in China)

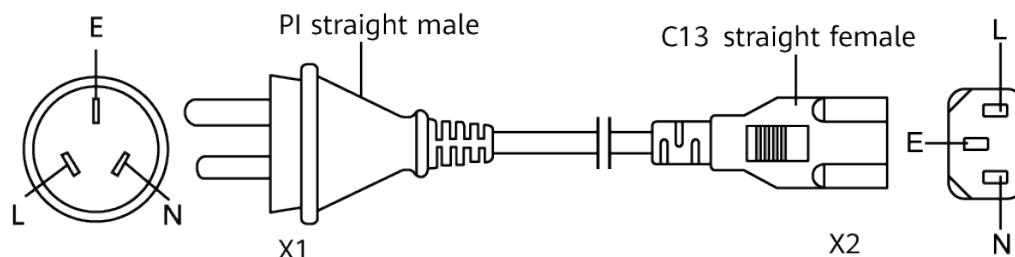

**Figure 5-15** Structure of a Cord end to C13 straight female AC power cable (used in China)

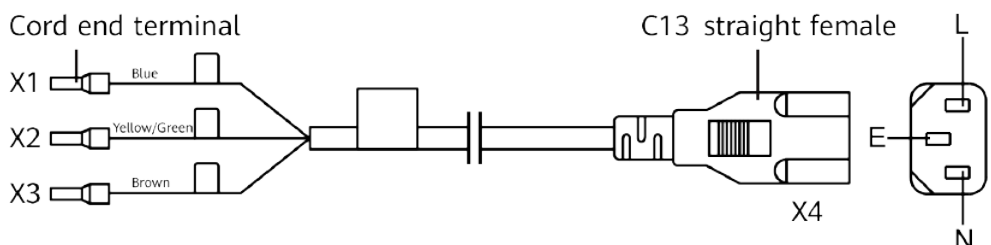

## Connection

**Table 5-5** shows connections of various AC power cables.

**Table 5-5** Connections of AC power cables

Power Cable Type	Connector Type and Connection	
C14 straight male to C13 straight female AC power cable	C14 straight male connector: connected to a PDU	C13 straight female connector: connected to the AC power

Power Cable Type	Connector Type and Connection	
PI straight male to C13 straight female AC power cable (used in China)	PI straight male connector: connected to a country-specific power strip	socket on the switch. The current rating of the power cable is 10 A.
Cord end to C13 straight female AC power cable (used in China)	Cord end terminal: connected to a power distribution box or power distribution frame. Connect the brown wire to the L terminal, blue wire to the N terminal, and the yellow/green wire to the ground terminal. Different AC power cables may be delivered in compliance with local regulations or customer requirements.	

## 5.5 Console Cable

### Appearance and Structure

[Figure 5-16](#) and [Figure 5-17](#) show the appearance and structure of a console cable.

**Figure 5-16** Appearance of a console cable



**Figure 5-17** Structure of a console cable

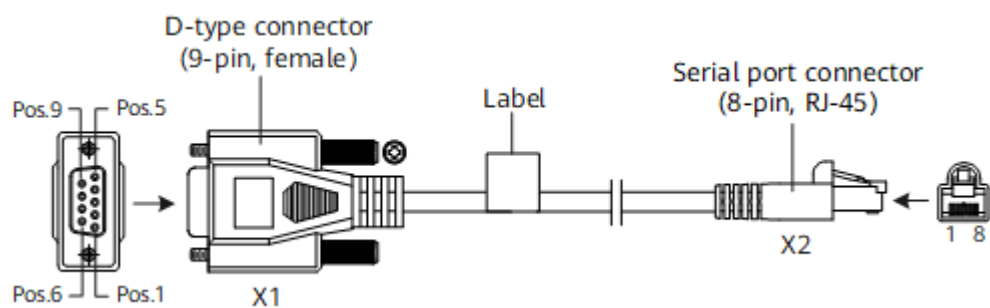

## Pin Assignments

**Table 5-6** lists the pin assignments of console cable connectors.

**Table 5-6** Pin assignments of console cable connectors

Connector	X1 (DB9)	X2 (RJ45)
Pin assignment	2	3
	3	6
	5	5

## Connection

A console cable connects the console port of the device to the serial port of an operation terminal to transmit configuration data. A shielded cable or an unshielded cable can be used according to the onsite situation.

A console cable connects the device and terminal as follows:

- The 8-pin RJ45 connector is inserted into the console port of the device.
- The DB9 connector is inserted into the terminal serial port.

# 6 Pluggable Modules for Interfaces

---

- [6.1 Important Notes About Using Optical Modules Certified for Huawei Switches](#)
- [6.2 Understanding Optical Modules](#)
- [6.3 Understanding Copper Modules](#)
- [6.4 FE SFP/eSFP Optical Modules](#)
- [6.5 GE eSFP Optical Modules](#)
- [6.6 GE-CWDM eSFP Optical Modules](#)
- [6.7 GE-DWDM eSFP Optical Modules](#)
- [6.8 GE SFP Copper Modules](#)

## 6.1 Important Notes About Using Optical Modules Certified for Huawei Switches

### 6.1.1 How to Identify Huawei-Certified Switch Optical Modules

---

#### NOTICE

- A switch must use optical or copper modules that have been certified for use on Huawei S switches. Non-certified optical or copper modules cannot ensure transmission reliability and may affect service stability. Huawei is not liable for any problem caused by the use of non-certified optical or copper modules and will not fix such problems.
  - The methods provided here are only for reference. To confirm whether optical modules you are using have been certified for use on Huawei S switches, contact Huawei technical support.
-

## 10GE or Lower Speed Optical Modules

Huawei started certification on 10GE or lower speed optical modules for S switch products on July 1, 2013.

To determine whether optical modules delivered for Huawei S switches before July 1, 2013 are certified ones, contact Huawei technical support.

If your optical modules are delivered after July 1, 2013, use either of the following methods to determine whether they have been certified by Huawei.

### Method 1: Check for "HUAWEI" on the label

If an optical module has been certified by Huawei, its label contains "HUAWEI", as shown in [Figure 6-1](#).

**Figure 6-1** "HUAWEI" on the label of a Huawei-certified S switch optical module



### Method 2: Run the command

An optical module has received Huawei S switch certification if it meets the following conditions:

For a device running V200 version:

- In the **display elabel** command output, the **Manufactured** field displays a date later than 2013-07-01.
- In the **display version** command output, the displayed version is V200R001C00 or later.
- In the **display transceiver** command output, the **Vendor Name** field displays **HUAWEI**.

For a device running V600 version:

- In the **display device elabel** command output, the **Manufactured** field displays a date later than 2013-07-01.
- In the **display version** command output, the displayed version is V600R021C00 or later.
- In the **display interface transceiver** command output, the **Vendor Name** field displays **HUAWEI**.

#### NOTE

The SFP-FE-SX-MM1310 (part number: 02315233) is a Huawei-certified 100M optical module. However, the **Vendor Name** field displays the original manufacturer name, instead of **HUAWEI**.

For copper modules, the **Vendor Name** field also displays the original manufacturer name, instead of **HUAWEI**.

## 6.1.2 Risks of Using Non-Huawei-Certified Switch Optical Modules

During certification of optical modules for Huawei switches, Huawei completes comprehensive functionality verification to ensure quality of optical modules. The verified items include optical module plug/unplug, transmit optical power, receive optical power, signal transmission quality, data reading, error tolerance, compatibility, electromagnetic compatibility (EMC), and environmental parameters.

Non-Huawei-certified switch optical modules may cause the following problems:

- Non-standard structure and size cause failures to install optical modules on adjacent optical interfaces.  
Structures or sizes of some non-Huawei-certified optical modules do not comply with the Multi-Source Agreement (MSA). When such an optical module is installed on an optical interface, the size of this optical module hinders optical module installation on adjacent optical interfaces.
- Data bus defects cause suspension of a switch's data bus.  
Some non-Huawei-certified optical modules have defects in data bus designs. Using such an optical module on a switch causes suspension of the connected data bus on the switch. As a result, data on the suspended bus cannot be read.
- Improper edge connector size damages electronic devices of optical interfaces.  
If a non-Huawei-certified switch optical module with improper edge connector size is used on an optical interface, electronic devices of the optical interface will be damaged by short circuits.
- Unnormalized temperature monitoring causes incorrect alarms.  
The temperature monitoring systems of some non-Huawei-certified switch optical modules do not comply with industry standards and report temperature values higher than the real temperature. When such optical modules are used on a switch, the system will report incorrect temperature alarms.
- Improper register settings cause errors or failures in reading parameters or diagnostic information.  
Some non-Huawei-certified switch optical modules have improper register values on page A0, which can cause errors or failures when the system attempts to read parameters or diagnostic information from a data bus.
- Some non-Huawei-certified switch optical modules are not designed in compliance with EMC standards and have low anti-interference capability. Additionally, they bring electromagnetic interference to nearby devices.
- The operating temperature ranges of non-Huawei-certified switch optical modules cannot meet service requirements. When they are used under relatively high temperature, the optical power decreases, resulting in service interruption.

## 6.2 Understanding Optical Modules

### 6.2.1 What Is an Optical Module

On an optical network, a sender needs to convert electrical signals into optical signals before sending them to a receiver, and the receiver needs to convert received optical signals into electrical signals. An optical module is a component that completes electrical/optical conversion on an optical network. **Figure 6-2** shows the structure of an optical module.

**Figure 6-2** Structure of an optical module (using an SFP/eSFP optical module as an example)

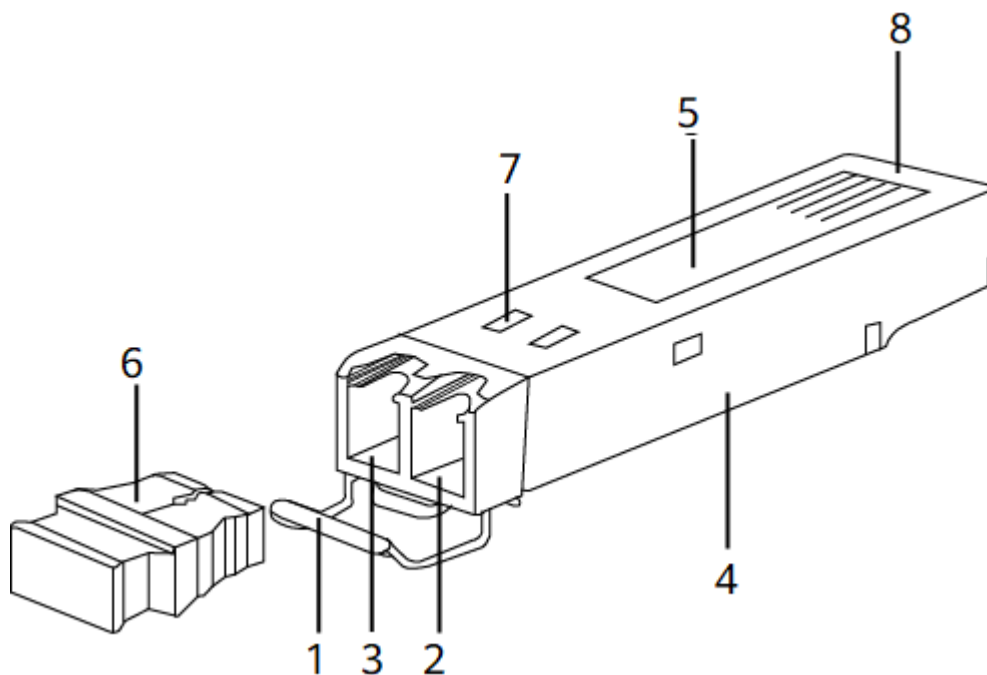

1. Handle	2. Receiver	3. Transmitter
4. Shell	5. Label	6. Dust plug
7. Spring	8. Connector	-

**Figure 6-3** shows an SFP/eSFP optical module.



Figure 6-3 SFP/eSFP optical module



## 6.2.2 Parameter Description

<b>Transmit optical power</b>	Output optical power of an optical module when it is working properly. When two optical modules are connected, the transmit optical power of one end must be within the range of receive optical power on the other end.
<b>Receive optical power</b>	Average input optical power that the receiver of an optical module can receive within a range of bit error rate (BER = $10^{-12}$ ). The upper limit of this parameter is the overload optical power and the lower limit is the maximum receiver sensitivity. When two optical modules are connected, the receive optical power on one end determines the range of transmit optical power on the other end.
<b>Maximum receiver sensitivity</b>	Minimum average input optical power that the receiver of an optical module can receive within a range of bit error rate (BER = $10^{-12}$ ). When two optical modules are connected, the maximum receiver sensitivity on one end determines the minimum value of transmit optical power on the other end.
<b>Overload optical power</b>	Maximum average input optical power that the receiver of an optical module can receive within a range of bit error rate (BER = $10^{-12}$ ). When two optical modules are connected, the overload optical power on one end determines the maximum transmit optical power on the other end.

<b>Extinction ratio</b>	Minimum ratio of the average optical power with signals transmitted against the average optical power without signals transmitted in complete modulation mode. The extinction ratio indicates the capability of an optical module to identify signal 0 and signal 1. This parameter is a quality indicator for optical modules. Optical modules with a large extinction ratio may not have good quality. Qualified optical modules should have an extinction ratio complying with IEEE 802.3.
<b>Fiber mode</b>	Mode of optical fibers defined based on core diameters and features of optical fibers. Optical fibers are classified into single-mode and multimode fibers. Generally, multimode fibers have large core diameters and severe dispersion, so they transmit optical signals over short distances. Single-mode fibers have low dispersion and can transmit optical signals over long distances.
<b>Modal bandwidth</b>	Bandwidth measured at a point with transmit power several dB lower than that of the point with the peak center wavelength. Modal bandwidth reflects spectrum characteristics of multimode fibers. The higher modal bandwidth a multimode fiber has, the longer transmission distance the fiber supports.
<b>Fiber diameter</b>	Diameter of the core of a fiber. According to international standards for optical fibers, the diameter of a multimode fiber is 62.5 $\mu\text{m}$ or 50 $\mu\text{m}$ , and the diameter of a single-mode fiber is 9 $\mu\text{m}$ . Select optical fibers with diameters supported by the optical modules.
<b>Fiber class</b>	Optical signals with different wavelengths have their best working windows in different optical fibers. To help efficiently adjust wavelengths or dispersion features of optical fibers and change their refractive indexes, the following fiber classes are defined: multimode fiber (G.651), common single-mode fiber (G.652), shifted dispersion fiber (G.653), and non-zero shifted dispersion fiber (G.655). G.651 and G.652 are commonly used fiber classes. Optical fibers of higher classes support longer transmission distances. When selecting optical fibers for optical modules, determine the classes of fibers based on the required transmission distances.
<b>Connector type</b>	Type of the interface on an optical module to accommodate a fiber. Commonly used connector types are LC (applicable to all the SFP, SFP+, and XFP modules), SC, and MPO (applicable to 150 m QSFP+ and CXP modules). Select optical fibers with connectors supported by the optical modules.
<b>Transmission distance</b>	Maximum distance over which optical signals can transmit. Optical signals sent from different types of sources can transmit over different distances due to negative effects of optical fibers, such as dispersion and attenuation. When connecting optical interfaces, select optical modules and fibers based on the maximum signal transmission distance.

<b>Interface rate</b>	Maximum rate of electrical signals that an optical component can transmit without bit errors. The interface rates defined in Ethernet standards include 125 Mbit/s, 1.25 Gbit/s, 10.3125 Gbit/s, and 41.25 Gbit/s. When connecting optical interfaces, select optical modules and fibers based on the maximum signal transmission rate.
<b>Center wavelength</b>	Wavelength measured at the midpoint of the half-amplitude line in the transmit spectrum. Two connected optical modules must have the same center wavelength.
<b>MSA</b>	Multi-Source Agreement, a non-profit organization jointly established by optical module manufacturers. This agreement defines the structure and dimensions of optical transceivers by referring to Optical Internetworking Forum (OIF) and International Telecommunication Union (ITU) standards.

## 6.2.3 How to View Optical Module Parameters

### Viewing the Hardware Description

If you know the model or type of an optical module, you can view the section "Pluggable Modules for Interfaces" in the *Hardware Description* to look up parameters of the optical module, including the center wavelength, transmission distance, fiber types supported, receive optical power, and transmit optical power.

### Using a Command

If an optical module is installed in a running device, you can run the **display interface transceiver** command to view parameters of the optical module, including the center wavelength, transmission distance, fiber types supported, receive optical power, and transmit optical power.

## 6.2.4 Rules for Optical Module Interoperation

### Interoperation Rules

Optical modules with the same standards can interoperate with each other. The standards define the rate, wavelength, and transmission distance of optical modules, but not their encapsulation modes (two interoperated optical modules can have different encapsulation modes).

If you need to achieve interoperability between optical modules with different standards, contact technical support personnel.

When S series devices are connected to other products such as routers, comply with the preceding optical module interoperation rules.

### Standards Description

The following describes the standards, using 1000BASE-LX10 as an example:

- 1000 indicates the rate (1000 Mbit/s, in this case). Other rates include 10 Mbit/s, 100 Mbit/s, 10 Gbit/s, 40 Gbit/s, and 100 Gbit/s.

- BASE indicates baseband transmission.
- L represents a center wavelength of the laser. Currently, the following center wavelengths are available: S (short wavelength: 850 nm), L (long wavelength: 1310 nm), E (extra long wavelength: 1550 nm), and B (single-fiber bidirectional long wavelength).
- X represents the encoding format. The encoding formats include T (twisted pair), X (8B/10B), R (64B/66B), and W (WIS).
- 10 indicates the number of channels. Currently, the value can be 4 or 10. If there is no number, the value is 1.

 **NOTE**

This example provides the definitions in IEEE standards, which are not applicable to all optical modules, for example, non-standard optical modules.

The following organizations or agreements define standards related to optical modules:

- IEEE 802.3, which defines MAC and PHY standards
- Small Form Factor (SFF) committee or Multi-Source Agreements (MSAs), which define optical module hardware, software, and structure standards

## 6.3 Understanding Copper Modules

Copper modules are also called RJ45 modules. Unlike optical modules, copper modules do not perform electrical-optical conversion. When two optical interfaces have copper modules installed, the interfaces can be connected using a copper cable. Currently, Huawei offers only GE copper modules with RJ45 interfaces. GE copper modules work with Category 5 network cables, comply with 1000BASE-T (IEEE 802.3ab), and support a maximum transmission distance of 100 m.

**Figure 6-4** shows a GE SFP copper module.

**Figure 6-4** Appearance of a GE SFP copper module

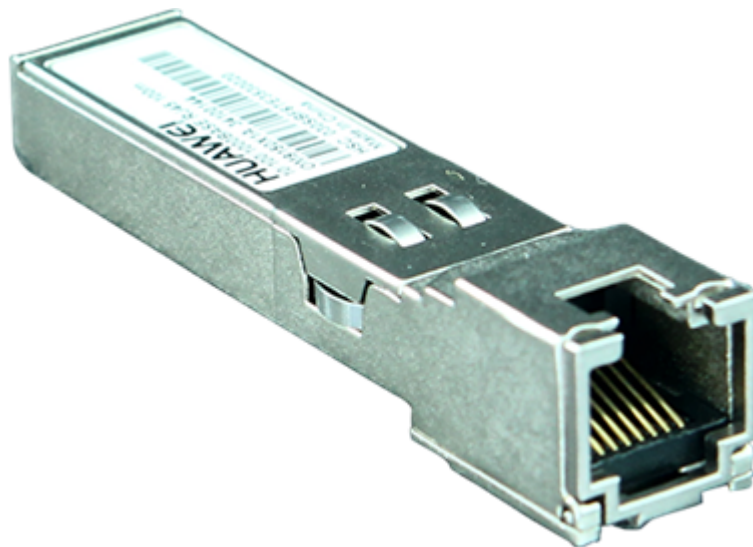

## 6.4 FE SFP/eSFP Optical Modules

## 6.4.1 SFP-FE-LX-SM1310-BIDI

**Table 6-1** SFP-FE-LX-SM1310-BIDI specifications

Item	Value
<b>Basic Information</b>	
Module name	SFP-FE-LX-SM1310-BIDI
Part Number	02315203
Model	SFP-FE-LX-SM1310-BIDI
Form factor	eSFP
Application standard	100BASE-BX
Connector type	LC
Optical fiber type	SMF
Working case temperature [°C(°F)]	0°C to 70°C (32°F to 158°F)
Transmission rate [bit/s]	100 Mbit/s
Target transmission distance [km]	Single-mode fiber: 15 km
<b>Transmitter Optical Characteristics</b>	
Center wavelength [nm]	1550 nm (RX) 1310 nm (TX)
Maximum Tx optical power [dBm]	-8.0 dBm
Minimum Tx optical power [dBm]	-15.0 dBm
Minimum extinction ratio [dB]	8.5 dB
<b>Receiver Optical Characteristics</b>	
Rx sensitivity [dBm]	-32.0 dBm
Overload power [dBm]	-8.0 dBm
<b>NOTE</b> Supports the single-fiber bidirectional function. BIDI optical modules must be used in pairs. For example, SFP-FE-LX-SM1310-BIDI must be used with SFP-FE-LX-SM1550-BIDI.	

## 6.4.2 SFP-FE-LX-SM1550-BIDI

**Table 6-2** SFP-FE-LX-SM1550-BIDI specifications

Item	Value
<b>Basic Information</b>	
Module name	SFP-FE-LX-SM1550-BIDI
Part Number	02315202
Model	SFP-FE-LX-SM1550-BIDI
Form factor	eSFP
Application standard	100BASE-BX
Connector type	LC
Optical fiber type	SMF
Working case temperature [°C(°F)]	0°C to 70°C (32°F to 158°F)
Transmission rate [bit/s]	100 Mbit/s
Target transmission distance [km]	Single-mode fiber: 15 km
<b>Transmitter Optical Characteristics</b>	
Center wavelength [nm]	1310 nm (RX) 1550 nm (TX)
Maximum Tx optical power [dBm]	-8.0 dBm
Minimum Tx optical power [dBm]	-15.0 dBm
Minimum extinction ratio [dB]	8.5 dB
<b>Receiver Optical Characteristics</b>	
Rx sensitivity [dBm]	-32.0 dBm
Overload power [dBm]	-8.0 dBm
<p><b>NOTE</b> Supports the single-fiber bidirectional function. BIDI optical modules must be used in pairs. For example, SFP-FE-LX-SM1550-BIDI must be used with SFP-FE-LX-SM1310-BIDI.</p>	

## 6.4.3 SFP-FE-SX-MM1310

**Table 6-3** SFP-FE-SX-MM1310 specifications

Item	Value
<b>Basic Information</b>	
Module name	SFP-FE-SX-MM1310
Part Number	02315233
Model	SFP-FE-SX-MM1310
Form factor	SFP
Application standard	100BASE-FX
Connector type	LC
Optical fiber type	MMF
Working case temperature [°C(°F)]	0°C to 70°C (32°F to 158°F)
Transmission rate [bit/s]	100 Mbit/s
Target transmission distance [km]	Multimode fiber (50 μm or 62.5 μm diameter): 2 km
<b>Transmitter Optical Characteristics</b>	
Center wavelength [nm]	1310 nm
Maximum Tx optical power [dBm]	-14.0 dBm
Minimum Tx optical power [dBm]	-19.0 dBm
Minimum extinction ratio [dB]	10 dB
<b>Receiver Optical Characteristics</b>	
Rx sensitivity [dBm]	-30.0 dBm
Overload power [dBm]	-14.0 dBm

## 6.4.4 eSFP-FE-LX-SM1310

**Table 6-4** eSFP-FE-LX-SM1310 specifications

Item	Value
<b>Basic Information</b>	
Module name	eSFP-FE-LX-SM1310
Part Number	02315205

Item	Value
Model	eSFP-FE-LX-SM1310
Form factor	eSFP
Application standard	Non-standard
Connector type	LC
Optical fiber type	SMF
Working case temperature [°C(°F)]	0°C to 70°C (32°F to 158°F)
Transmission rate [bit/s]	100 Mbit/s
Target transmission distance [km]	Single-mode fiber: 15 km
<b>Transmitter Optical Characteristics</b>	
Center wavelength [nm]	1310 nm
Maximum Tx optical power [dBm]	-8.0 dBm
Minimum Tx optical power [dBm]	-15.0 dBm
Minimum extinction ratio [dB]	8.2 dB
<b>Receiver Optical Characteristics</b>	
Rx sensitivity [dBm]	-28.0 dBm
Overload power [dBm]	-8.0 dBm

## 6.5 GE eSFP Optical Modules

### 6.5.1 LE2MGSC40DE0

Table 6-5 LE2MGSC40DE0 specifications

Item	Value
<b>Basic Information</b>	
Module name	LE2MGSC40DE0
Part Number	02310KVV
Model	LE2MGSC40DE0
Form factor	eSFP
Application standard	1000BASE-BX
Connector type	LC



Item	Value
Optical fiber type	SMF
Working case temperature [°C(°F)]	0°C to 70°C (32°F to 158°F)
Transmission rate [bit/s]	1 Gbit/s
Target transmission distance [km]	Single-mode fiber: 40 km
<b>Transmitter Optical Characteristics</b>	
Center wavelength [nm]	1490 nm (RX) 1310 nm (TX)
Maximum Tx optical power [dBm]	3.0 dBm
Minimum Tx optical power [dBm]	-2.0 dBm
Minimum extinction ratio [dB]	9 dB
<b>Receiver Optical Characteristics</b>	
Rx sensitivity [dBm]	-23 dBm
Overload power [dBm]	-3.0 dBm
<b>NOTE</b> Supports the single-wire bidirectional function. Single-fiber bidirectional (BIDI) optical modules must be used in pairs. For example, LE2MGSC40DE0 must be used with LE2MGSC40ED0.	

## 6.5.2 LE2MGSC40ED0

Table 6-6 LE2MGSC40ED0 specifications

Item	Value
<b>Basic Information</b>	
Module name	LE2MGSC40ED0
Part Number	02310KVU
Model	LE2MGSC40ED0
Form factor	eSFP
Application standard	1000BASE-BX
Connector type	LC
Optical fiber type	SMF
Working case temperature [°C(°F)]	0°C to 70°C (32°F to 158°F)

Item	Value
Transmission rate [bit/s]	1 Gbit/s
Target transmission distance [km]	Single-mode fiber: 40 km
<b>Transmitter Optical Characteristics</b>	
Center wavelength [nm]	1310 nm (RX) 1490 nm (TX)
Maximum Tx optical power [dBm]	3.0 dBm
Minimum Tx optical power [dBm]	-2.0 dBm
Minimum extinction ratio [dB]	9 dB
<b>Receiver Optical Characteristics</b>	
Rx sensitivity [dBm]	-23 dBm
Overload power [dBm]	-3.0 dBm
<b>NOTE</b> Supports the single-fiber bidirectional function. Single-fiber bidirectional (BIDI) optical modules must be used in pairs. For example, LE2MGSC40ED0 must be used with LE2MGSC40DE0.	

### 6.5.3 S-SFP-GE-LH40-SM1310

Table 6-7 S-SFP-GE-LH40-SM1310 specifications

Item	Value
<b>Basic Information</b>	
Module name	S-SFP-GE-LH40-SM1310
Part Number	02317346
Model	S-SFP-GE-LH40-SM1310
Form factor	eSFP
Application standard	1000BASE-EX (non-standard)
Connector type	LC
Optical fiber type	SMF
Working case temperature [°C(°F)]	0°C to 70°C (32°F to 158°F)
Transmission rate [bit/s]	1 Gbit/s
Target transmission distance [km]	Single-mode fiber: 40 km

Item	Value
<b>Transmitter Optical Characteristics</b>	
Center wavelength [nm]	1310 nm
Maximum Tx optical power [dBm]	0 dBm
Minimum Tx optical power [dBm]	-5.0 dBm
Minimum extinction ratio [dB]	9 dB
<b>Receiver Optical Characteristics</b>	
Rx sensitivity [dBm]	-23 dBm
Overload power [dBm]	-3.0 dBm

## 6.5.4 S-SFP-GE-LH40-SM1550

**Table 6-8** S-SFP-GE-LH40-SM1550 specifications

Item	Value
<b>Basic Information</b>	
Module name	S-SFP-GE-LH40-SM1550
Part Number	02317347
Model	S-SFP-GE-LH40-SM1550
Form factor	eSFP
Application standard	Non-standard
Connector type	LC
Optical fiber type	SMF
Working case temperature [°C(°F)]	0°C to 70°C (32°F to 158°F)
Transmission rate [bit/s]	1 Gbit/s
Target transmission distance [km]	Single-mode fiber: 40 km
<b>Transmitter Optical Characteristics</b>	
Center wavelength [nm]	1550 nm
Maximum Tx optical power [dBm]	0 dBm
Minimum Tx optical power [dBm]	-5.0 dBm
Minimum extinction ratio [dB]	9 dB
<b>Receiver Optical Characteristics</b>	

Item	Value
Rx sensitivity [dBm]	-22 dBm
Overload power [dBm]	-3.0 dBm

## 6.5.5 S-SFP-GE-LH80-SM1550

**Table 6-9** S-SFP-GE-LH80-SM1550 specifications

Item	Value
<b>Basic Information</b>	
Module name	S-SFP-GE-LH80-SM1550
Part Number	02317348
Model	S-SFP-GE-LH80-SM1550
Form factor	eSFP
Application standard	1000BASE-ZX
Connector type	LC
Optical fiber type	SMF
Working case temperature [°C(°F)]	0°C to 70°C (32°F to 158°F)
Transmission rate [bit/s]	1 Gbit/s
Target transmission distance [km]	Single-mode fiber: 80 km
<b>Transmitter Optical Characteristics</b>	
Center wavelength [nm]	1550 nm
Maximum Tx optical power [dBm]	5.0 dBm
Minimum Tx optical power [dBm]	-2.0 dBm
Minimum extinction ratio [dB]	9 dB
<b>Receiver Optical Characteristics</b>	
Rx sensitivity [dBm]	-23 dBm
Overload power [dBm]	-3.0 dBm

## 6.5.6 SFP-GE-BXU1-SC

**Table 6-10** SFP-GE-BXU1-SC specifications

Item	Value
<b>Basic Information</b>	
Module name	SFP-GE-BXU1-SC
Part Number	02310TQH
Model	SFP-GE-BXU1-SC
Form factor	eSFP
Application standard	Non-standard
Connector type	SC
Optical fiber type	SMF
Working case temperature [°C(°F)]	0°C to 70°C (32°F to 158°F)
Transmission rate [bit/s]	1 Gbit/s
Target transmission distance [km]	Single-mode fiber: 10 km
<b>Transmitter Optical Characteristics</b>	
Center wavelength [nm]	1310 nm (RX) 1490 nm (TX)
Maximum Tx optical power [dBm]	-3.0 dBm
Minimum Tx optical power [dBm]	-9.0 dBm
Minimum extinction ratio [dB]	9 dB
<b>Receiver Optical Characteristics</b>	
Rx sensitivity [dBm]	-19.5 dBm
Overload power [dBm]	-3.0 dBm
<b>NOTE</b> This module supports the single-fiber bidirectional function.	

## 6.5.7 SFP-GE-EX-C

**Table 6-11** SFP-GE-EX-C specifications

Item	Value
<b>Basic Information</b>	

Item	Value
Module name	SFP-GE-EX-C
Part Number	02312UUD
Model	SFP-GE-EX-C
Form factor	eSFP
Application standard	1000BASE-EX (non-standard)
Connector type	LC
Optical fiber type	SMF
Working case temperature [°C(°F)]	0°C to 70°C (32°F to 158°F)
Transmission rate [bit/s]	1 Gbit/s
Target transmission distance [km]	Single-mode fiber: 40 km
<b>Transmitter Optical Characteristics</b>	
Center wavelength [nm]	1310 nm
Maximum Tx optical power [dBm]	0 dBm
Minimum Tx optical power [dBm]	-5.0 dBm
Minimum extinction ratio [dB]	9 dB
<b>Receiver Optical Characteristics</b>	
Rx sensitivity [dBm]	-23 dBm
Overload power [dBm]	-3.0 dBm

## 6.5.8 SFP-GE-LX-SM1310 (02315200)

**Table 6-12** SFP-GE-LX-SM1310 specifications

Item	Value
<b>Basic Information</b>	
Module name	SFP-GE-LX-SM1310
Part Number	02315200
Model	SFP-GE-LX-SM1310
Form factor	eSFP
Application standard	1000BASE-LX10/LH
Connector type	LC

Item	Value
Optical fiber type	SMF
Working case temperature [°C(°F)]	0°C to 70°C (32°F to 158°F)
Transmission rate [bit/s]	1 Gbit/s
Target transmission distance [km]	Single-mode fiber: 10 km
<b>Transmitter Optical Characteristics</b>	
Center wavelength [nm]	1310 nm
Maximum Tx optical power [dBm]	-3.0 dBm
Minimum Tx optical power [dBm]	-9.0 dBm
Minimum extinction ratio [dB]	9 dB
<b>Receiver Optical Characteristics</b>	
Rx sensitivity [dBm]	-20.0 dBm
Overload power [dBm]	-3.0 dBm

## 6.5.9 SFP-GE-LX-SM1310-BIDI (02315285)

Table 6-13 SFP-GE-LX-SM1310-BIDI specifications

Item	Value
<b>Basic Information</b>	
Module name	SFP-GE-LX-SM1310-BIDI
Part Number	02315285
Model	SFP-GE-LX-SM1310-BIDI
Form factor	eSFP
Application standard	1000BASE-BX10
Connector type	LC
Optical fiber type	SMF
Working case temperature [°C(°F)]	0°C to 70°C (32°F to 158°F)
Transmission rate [bit/s]	1 Gbit/s
Target transmission distance [km]	Single-mode fiber: 10 km
<b>Transmitter Optical Characteristics</b>	

Item	Value
Center wavelength [nm]	1490 nm (RX) 1310 nm (TX)
Maximum Tx optical power [dBm]	-3.0 dBm
Minimum Tx optical power [dBm]	-9.0 dBm
Minimum extinction ratio [dB]	6 dB
<b>Receiver Optical Characteristics</b>	
Rx sensitivity [dBm]	-19.5 dBm
Overload power [dBm]	-3.0 dBm
<b>NOTE</b> Supports the single-fiber bidirectional function. Single-fiber bidirectional (BIDI) optical modules must be used in pairs. For example, SFP-GE-LX-SM1310-BIDI must be used with SFP-GE-LX-SM1490-BIDI.	

## 6.5.10 SFP-GE-LX-SM1490-BIDI (02315286)

**Table 6-14** SFP-GE-LX-SM1490-BIDI specifications

Item	Value
<b>Basic Information</b>	
Module name	SFP-GE-LX-SM1490-BIDI
Part Number	02315286
Model	SFP-GE-LX-SM1490-BIDI
Form factor	eSFP
Application standard	1000BASE-BX10
Connector type	LC
Optical fiber type	SMF
Working case temperature [°C(°F)]	0°C to 70°C (32°F to 158°F)
Transmission rate [bit/s]	1 Gbit/s
Target transmission distance [km]	Single-mode fiber: 10 km
<b>Transmitter Optical Characteristics</b>	
Center wavelength [nm]	1310 nm (RX) 1490 nm (TX)
Maximum Tx optical power [dBm]	-3.0 dBm



Item	Value
Minimum Tx optical power [dBm]	-9.0 dBm
Minimum extinction ratio [dB]	6 dB
<b>Receiver Optical Characteristics</b>	
Rx sensitivity [dBm]	-19.5 dBm
Overload power [dBm]	-3.0 dBm
<b>NOTE</b> Supports the single-fiber bidirectional function. Single-fiber bidirectional (BIDI) optical modules must be used in pairs. For example, SFP-GE-LX-SM1490-BIDI must be used with SFP-GE-LX-SM1310-BIDI.	

## 6.5.11 SFP-GE-LX10-C

**Table 6-15** SFP-GE-LX10-C specifications

Item	Value
<b>Basic Information</b>	
Module name	SFP-GE-LX10-C
Part Number	02312UUC
Model	SFP-GE-LX10-C
Form factor	eSFP
Application standard	1000BASE-LX10/LH
Connector type	LC
Optical fiber type	SMF
Working case temperature [°C(°F)]	0°C to 70°C (32°F to 158°F)
Transmission rate [bit/s]	1 Gbit/s
Target transmission distance [km]	Single-mode fiber: 10 km
<b>Transmitter Optical Characteristics</b>	
Center wavelength [nm]	1310 nm
Maximum Tx optical power [dBm]	-3.0 dBm
Minimum Tx optical power [dBm]	-9.0 dBm
Minimum extinction ratio [dB]	9 dB
<b>Receiver Optical Characteristics</b>	

Item	Value
Rx sensitivity [dBm]	-20.0 dBm
Overload power [dBm]	-3.0 dBm

## 6.5.12 SFP-GE-SX-C (02312UUB)

**Table 6-16** SFP-GE-SX-C specifications

Item	Value
<b>Basic Information</b>	
Module name	SFP-GE-SX-C
Part Number	02312UUB
Model	SFP-GE-SX-C
Form factor	eSFP
Application standard	1000BASE-SX
Connector type	LC
Optical fiber type	MMF
Working case temperature [°C(°F)]	-20°C to +85°C (-4°F to +185°F)
Transmission rate [bit/s]	1 Gbit/s
Target transmission distance [km]	Multimode optical fiber (modal bandwidth: 160 MHz*km; diameter: 62.5 μm): 0.22 km Multimode optical fiber (OM1): 0.275 km Multimode optical fiber (modal bandwidth: 400 MHz*km; diameter: 50 μm): 0.5 km Multimode optical fiber (OM2): 0.55 km Multimode optical fiber (OM3): 1 km
<b>Transmitter Optical Characteristics</b>	
Center wavelength [nm]	850 nm
Maximum Tx optical power [dBm]	-2.5 dBm
Minimum Tx optical power [dBm]	-9.5 dBm
Minimum extinction ratio [dB]	9 dB

Item	Value
<b>Receiver Optical Characteristics</b>	
Rx sensitivity [dBm]	-17.0 dBm
Overload power [dBm]	0 dBm

## 6.5.13 SFP-GE-ZBXD1

**Table 6-17** SFP-GE-ZBXD1 specifications

Item	Value
<b>Basic Information</b>	
Module name	SFP-GE-ZBXD1
Part Number	02311DDB
Model	SFP-GE-ZBXD1
Form factor	eSFP
Application standard	Non-standard
Connector type	LC
Optical fiber type	SMF
Working case temperature [°C(°F)]	0°C to 70°C (32°F to 158°F)
Transmission rate [bit/s]	1 Gbit/s
Target transmission distance [km]	Single-mode fiber: 80 km
<b>Transmitter Optical Characteristics</b>	
Center wavelength [nm]	1490 nm (RX) 1570 nm (TX)
Maximum Tx optical power [dBm]	4.0 dBm
Minimum Tx optical power [dBm]	-2.0 dBm
Minimum extinction ratio [dB]	9 dB
<b>Receiver Optical Characteristics</b>	
Rx sensitivity [dBm]	-26 dBm
Overload power [dBm]	-3.0 dBm

Item	Value
<b>NOTE</b> Single-fiber bidirectional transmission is supported. Single-fiber bidirectional (BIDI) optical modules must be used in pairs. For example, SFP-GE-ZBXD1 must be used with SFP-GE-ZBXU1.	

## 6.5.14 SFP-GE-ZBXU1

**Table 6-18** SFP-GE-ZBXU1 specifications

Item	Value
<b>Basic Information</b>	
Module name	SFP-GE-ZBXU1
Part Number	02311DDC
Model	SFP-GE-ZBXU1
Form factor	eSFP
Application standard	Non-standard
Connector type	LC
Optical fiber type	SMF
Working case temperature [°C(°F)]	0°C to 70°C (32°F to 158°F)
Transmission rate [bit/s]	1 Gbit/s
Target transmission distance [km]	Single-mode fiber: 80 km
<b>Transmitter Optical Characteristics</b>	
Center wavelength [nm]	1570 nm (RX) 1490 nm (TX)
Maximum Tx optical power [dBm]	4.0 dBm
Minimum Tx optical power [dBm]	-2.0 dBm
Minimum extinction ratio [dB]	9 dB
<b>Receiver Optical Characteristics</b>	
Rx sensitivity [dBm]	-26 dBm
Overload power [dBm]	-3.0 dBm
<b>NOTE</b> Single-fiber bidirectional transmission is supported. Single-fiber bidirectional (BIDI) optical modules must be used in pairs. For example, SFP-GE-ZBXU1 must be used with SFP-GE-ZBXD1.	

## 6.5.15 eSFP-GE-SX-MM850 (02315204)

**Table 6-19** eSFP-GE-SX-MM850 specifications

Item	Value
<b>Basic Information</b>	
Module name	eSFP-GE-SX-MM850
Part Number	02315204
Model	eSFP-GE-SX-MM850
Form factor	eSFP
Application standard	1000BASE-SX
Connector type	LC
Optical fiber type	MMF
Working case temperature [°C(°F)]	-20°C to +85°C (-4°F to +185°F)
Transmission rate [bit/s]	1 Gbit/s
Target transmission distance [km]	Multimode optical fiber (modal bandwidth: 160 MHz*km; diameter: 62.5 μm): 0.22 km Multimode optical fiber (OM1): 0.275 km Multimode optical fiber (modal bandwidth: 400 MHz*km; diameter: 50 μm): 0.5 km Multimode optical fiber (OM2): 0.55 km Multimode optical fiber (OM3): 1 km
<b>Transmitter Optical Characteristics</b>	
Center wavelength [nm]	850 nm
Maximum Tx optical power [dBm]	-2.5 dBm
Minimum Tx optical power [dBm]	-9.5 dBm
Minimum extinction ratio [dB]	9 dB
<b>Receiver Optical Characteristics</b>	
Rx sensitivity [dBm]	-17.0 dBm
Overload power [dBm]	0 dBm

## 6.5.16 eSFP-GE-ZX100-SM1550

**Table 6-20** eSFP-GE-ZX100-SM1550 specifications

Item	Value
<b>Basic Information</b>	
Module name	eSFP-GE-ZX100-SM1550
Part Number	02315206
Model	eSFP-GE-ZX100-SM1550
Form factor	eSFP
Application standard	1000BASE-ZX
Connector type	LC
Optical fiber type	SMF
Working case temperature [°C(°F)]	0°C to 70°C (32°F to 158°F)
Transmission rate [bit/s]	1 Gbit/s
Target transmission distance [km]	Single-mode fiber: 100 km
<b>Transmitter Optical Characteristics</b>	
Center wavelength [nm]	1550 nm
Maximum Tx optical power [dBm]	5 dBm
Minimum Tx optical power [dBm]	0 dBm
Minimum extinction ratio [dB]	9.5 dB
<b>Receiver Optical Characteristics</b>	
Rx sensitivity [dBm]	-30.0 dBm
Overload power [dBm]	-9.0 dBm

## 6.5.17 OGSC10DD0

**Table 6-21** OGSC10DD0 specifications

Item	Value
<b>Basic Information</b>	
Module name	OGSC10DD0
Part Number	02310LJH

Item	Value
Model	OGSC10DD0
Form factor	eSFP
Application standard	1000BASE-LX10/LH
Connector type	LC
Optical fiber type	SMF
Working case temperature [°C(°F)]	-40°C to +85°C (-40°F to +185°F)
Transmission rate [bit/s]	1 Gbit/s
Target transmission distance [km]	Single-mode fiber: 10 km
<b>Transmitter Optical Characteristics</b>	
Center wavelength [nm]	1310 nm
Maximum Tx optical power [dBm]	-3.0 dBm
Minimum Tx optical power [dBm]	-9.0 dBm
Minimum extinction ratio [dB]	9.5 dB
<b>Receiver Optical Characteristics</b>	
Rx sensitivity [dBm]	-19 dBm
Overload power [dBm]	-3.0 dBm

## 6.5.18 OGSC40DD0

Table 6-22 OGSC40DD0 specifications

Item	Value
<b>Basic Information</b>	
Module name	OGSC40DD0
Part Number	02310LJJ
Model	OGSC40DD0
Form factor	eSFP
Application standard	Non-standard
Connector type	LC
Optical fiber type	SMF
Working case temperature [°C(°F)]	-40°C to +85°C (-40°F to +185°F)

Item	Value
Transmission rate [bit/s]	1 Gbit/s
Target transmission distance [km]	Single-mode fiber: 40 km
<b>Transmitter Optical Characteristics</b>	
Center wavelength [nm]	1310 nm
Maximum Tx optical power [dBm]	0 dBm
Minimum Tx optical power [dBm]	-5.0 dBm
Minimum extinction ratio [dB]	9 dB
<b>Receiver Optical Characteristics</b>	
Rx sensitivity [dBm]	-22.5 dBm
Overload power [dBm]	-3.0 dBm

## 6.5.19 OGSM01880

Table 6-23 OGSM01880 specifications

Item	Value
<b>Basic Information</b>	
Module name	OGSM01880
Part Number	02310LJG
Model	OGSM01880
Form factor	eSFP
Application standard	1000BASE-SX
Connector type	LC
Optical fiber type	MMF
Working case temperature [°C(°F)]	-40°C to +85°C (-40°F to +185°F)
Transmission rate [bit/s]	1 Gbit/s



Item	Value
Target transmission distance [km]	Multimode fiber (with modal bandwidth of 160 MHz*km and diameter of 62.5 μm): 0.22 km Multimode fiber (OM1): 0.275 km Multimode fiber (with modal bandwidth of 400 MHz*km and diameter of 50 μm): 0.5 km Multimode fiber (OM2): 0.55 km
<b>Transmitter Optical Characteristics</b>	
Center wavelength [nm]	850 nm
Maximum Tx optical power [dBm]	-2.5 dBm
Minimum Tx optical power [dBm]	-10 dBm
Minimum extinction ratio [dB]	9 dB
<b>Receiver Optical Characteristics</b>	
Rx sensitivity [dBm]	-17.0 dBm
Overload power [dBm]	0 dBm

## 6.5.20 SFP-GE-BX-D1-I

**Table 6-24** SFP-GE-BX-D1-I specifications

Item	Value
<b>Basic Information</b>	
Module name	SFP-GE-BX-D1-I
Part Number	02311DMA
Model	SFP-GE-BX-D1-I
Form factor	SFP
Application standard	1000BASE-BX
Connector type	LC
Optical fiber type	SMF
Working case temperature [°C(°F)]	-40°C to +85°C (-40°F to +185°F)
Transmission rate [bit/s]	1 Gbit/s
Target transmission distance [km]	Single-mode fiber: 10 km

Item	Value
<b>Transmitter Optical Characteristics</b>	
Center wavelength [nm]	1310 nm (RX) 1490 nm (TX)
Maximum Tx optical power [dBm]	-3 dBm
Minimum Tx optical power [dBm]	-9 dBm
Minimum extinction ratio [dB]	9 dB
<b>Receiver Optical Characteristics</b>	
Rx sensitivity [dBm]	-19.5 dBm
Overload power [dBm]	-3 dBm
<b>NOTE</b> Supports the single-fiber bidirectional function. Single-fiber bidirectional (BIDI) optical modules must be used in pairs. For example, SFP-GE-BX-D1-I must be used with SFP-GE-BX-U1-I.	

## 6.5.21 SFP-GE-BX-U1-I

Table 6-25 SFP-GE-BX-U1-I specifications

Item	Value
<b>Basic Information</b>	
Module name	SFP-GE-BX-U1-I
Part Number	02311DMF
Model	SFP-GE-BX-U1-I
Form factor	SFP
Application standard	1000BASE-BX
Connector type	LC
Optical fiber type	SMF
Working case temperature [°C(°F)]	-40°C to +85°C (-40°F to +185°F)
Transmission rate [bit/s]	1 Gbit/s
Target transmission distance [km]	Single-mode fiber: 10 km
<b>Transmitter Optical Characteristics</b>	
Center wavelength [nm]	1490 nm (RX) 1310 nm (TX)

Item	Value
Maximum Tx optical power [dBm]	-3 dBm
Minimum Tx optical power [dBm]	-9 dBm
Minimum extinction ratio [dB]	9 dB
<b>Receiver Optical Characteristics</b>	
Rx sensitivity [dBm]	-19.5 dBm
Overload power [dBm]	-3 dBm
<b>NOTE</b> Supports the single-fiber bidirectional function. Single-fiber bidirectional (BIDI) optical modules must be used in pairs. For example, SFP-GE-BX-D1-I must be used with SFP-GE-BX-U1-I.	

## 6.5.22 SFP-GE-BX40-D-I

Table 6-26 SFP-GE-BX40-D-I specifications

Item	Value
<b>Basic Information</b>	
Module name	SFP-GE-BX40-D-I
Part Number	02312TMC
Model	SFP-GE-BX40-D-I
Form factor	SFP
Application standard	1000BASE-BX
Connector type	LC
Optical fiber type	SMF
Working case temperature [°C(°F)]	-40°C to +85°C (-40°F to +185°F)
Transmission rate [bit/s]	1 Gbit/s
Target transmission distance [km]	Single-mode fiber: 40 km
<b>Transmitter Optical Characteristics</b>	
Center wavelength [nm]	1310 nm (RX) 1490 nm (TX)
Maximum Tx optical power [dBm]	6.5 dBm
Minimum Tx optical power [dBm]	1.5 dBm

Item	Value
Minimum extinction ratio [dB]	8.2 dB
<b>Receiver Optical Characteristics</b>	
Rx sensitivity [dBm]	-26 dBm
Overload power [dBm]	-7 dBm
<b>NOTE</b> Supports the single-fiber bidirectional function. Single-fiber bidirectional (BIDI) optical modules must be used in pairs. For example, SFP-GE-BX40-D-I must be used with SFP-GE-BX40-U-I.	

## 6.5.23 SFP-GE-BX40-U-I

Table 6-27 SFP-GE-BX40-U-I specifications

Item	Value
<b>Basic Information</b>	
Module name	SFP-GE-BX40-U-I
Part Number	02312TMB
Model	SFP-GE-BX40-U-I
Form factor	SFP
Application standard	1000BASE-BX
Connector type	LC
Optical fiber type	SMF
Working case temperature [°C(°F)]	-40°C to +85°C (-40°F to +185°F)
Transmission rate [bit/s]	1 Gbit/s
Target transmission distance [km]	Single-mode fiber: 40 km
<b>Transmitter Optical Characteristics</b>	
Center wavelength [nm]	1490 nm (RX) 1310 nm (TX)
Maximum Tx optical power [dBm]	6.5 dBm
Minimum Tx optical power [dBm]	1.5 dBm
Minimum extinction ratio [dB]	8.2 dB
<b>Receiver Optical Characteristics</b>	

Item	Value
Rx sensitivity [dBm]	-26 dBm
Overload power [dBm]	-7 dBm
<b>NOTE</b> Supports the single-fiber bidirectional function. Single-fiber bidirectional (BIDI) optical modules must be used in pairs. For example, SFP-GE-BX40-U-I must be used with SFP-GE-BX40-D-I.	

## 6.5.24 eSFP-GE-SX-MM850 (02313URD)

Table 6-28 eSFP-GE-SX-MM850 specifications

Item	Value
<b>Basic Information</b>	
Module name	eSFP-GE-SX-MM850
Part Number	02313URD
Model	eSFP-GE-SX-MM850
Form factor	eSFP
Application standard	1000BASE-SX
Connector type	LC
Optical fiber type	MMF
Working case temperature [°C(°F)]	-20°C to +85°C (-4°F to +185°F)
Transmission rate [bit/s]	1 Gbit/s
Target transmission distance [km]	Multimode optical fiber (modal bandwidth: 160 MHz*km; diameter: 62.5 μm): 0.22 km Multimode optical fiber (OM1): 0.275 km Multimode optical fiber (modal bandwidth: 400 MHz*km; diameter: 50 μm): 0.5 km Multimode optical fiber (OM2): 0.55 km Multimode optical fiber (OM3): 1 km
<b>Transmitter Optical Characteristics</b>	
Center wavelength [nm]	850 nm
Maximum Tx optical power [dBm]	-2.5 dBm

Item	Value
Minimum Tx optical power [dBm]	-9.5 dBm
Minimum extinction ratio [dB]	9 dB
<b>Receiver Optical Characteristics</b>	
Rx sensitivity [dBm]	-17.0 dBm
Overload power [dBm]	0 dBm

## 6.5.25 SFP-GE-LX-SM1310 (02313URF)

**Table 6-29** SFP-GE-LX-SM1310 specifications

Item	Value
<b>Basic Information</b>	
Module name	SFP-GE-LX-SM1310
Part Number	02313URF
Model	SFP-GE-LX-SM1310
Form factor	eSFP
Application standard	1000BASE-LX10/LH
Connector type	LC
Optical fiber type	SMF
Working case temperature [°C(°F)]	0°C to 70°C (32°F to 158°F)
Transmission rate [bit/s]	1 Gbit/s
Target transmission distance [km]	Single-mode fiber: 10 km
<b>Transmitter Optical Characteristics</b>	
Center wavelength [nm]	1310 nm
Maximum Tx optical power [dBm]	-3.0 dBm
Minimum Tx optical power [dBm]	-9.0 dBm
Minimum extinction ratio [dB]	9 dB
<b>Receiver Optical Characteristics</b>	
Rx sensitivity [dBm]	-20.0 dBm
Overload power [dBm]	-3.0 dBm

## 6.5.26 SFP-GE-SX-C (02314KKF)

**Table 6-30** SFP-GE-SX-C specifications

Item	Value
<b>Basic Information</b>	
Module name	SFP-GE-SX-C
Part Number	02314KKF
Model	SFP-GE-SX-C
Form factor	eSFP
Application standard	1000BASE-SX
Connector type	LC
Optical fiber type	MMF
Working case temperature [°C(°F)]	-20°C to +85°C (-4°F to +185°F)
Transmission rate [bit/s]	1 Gbit/s
Target transmission distance [km]	Multimode optical fiber (modal bandwidth: 160 MHz*km; diameter: 62.5 μm): 0.22 km Multimode optical fiber (OM1): 0.275 km Multimode optical fiber (modal bandwidth: 400 MHz*km; diameter: 50 μm): 0.5 km Multimode optical fiber (OM2): 0.55 km Multimode optical fiber (OM3): 1 km
<b>Transmitter Optical Characteristics</b>	
Center wavelength [nm]	850 nm
Maximum Tx optical power [dBm]	-2.5 dBm
Minimum Tx optical power [dBm]	-9.5 dBm
Minimum extinction ratio [dB]	9 dB
<b>Receiver Optical Characteristics</b>	
Rx sensitivity [dBm]	-17.0 dBm
Overload power [dBm]	0 dBm

## 6.5.27 SFP-GE-LX-SM1310-BIDI (02314KKJ)

**Table 6-31** SFP-GE-LX-SM1310-BIDI specifications

Item	Value
<b>Basic Information</b>	
Module name	SFP-GE-LX-SM1310-BIDI
Part Number	02314KKJ
Model	SFP-GE-LX-SM1310-BIDI
Form factor	eSFP
Application standard	1000BASE-BX10
Connector type	LC
Optical fiber type	SMF
Working case temperature [°C(°F)]	0°C to 70°C (32°F to 158°F)
Transmission rate [bit/s]	1 Gbit/s
Target transmission distance [km]	Single-mode fiber: 10 km
<b>Transmitter Optical Characteristics</b>	
Center wavelength [nm]	1490 nm (RX) 1310 nm (TX)
Maximum Tx optical power [dBm]	-3.0 dBm
Minimum Tx optical power [dBm]	-9.0 dBm
Minimum extinction ratio [dB]	6 dB
<b>Receiver Optical Characteristics</b>	
Rx sensitivity [dBm]	-19.5 dBm
Overload power [dBm]	-3.0 dBm
<b>NOTE</b> Supports the single-fiber bidirectional function. Single-fiber bidirectional (BIDI) optical modules must be used in pairs. For example, SFP-GE-LX-SM1310-BIDI must be used with SFP-GE-LX-SM1490-BIDI.	



## 6.5.28 SFP-GE-LX-SM1490-BIDI (02314KKH)

**Table 6-32** SFP-GE-LX-SM1490-BIDI specifications

Item	Value
<b>Basic Information</b>	
Module name	SFP-GE-LX-SM1490-BIDI
Part Number	02314KKH
Model	SFP-GE-LX-SM1490-BIDI
Form factor	eSFP
Application standard	1000BASE-BX10
Connector type	LC
Optical fiber type	SMF
Working case temperature [°C(°F)]	0°C to 70°C (32°F to 158°F)
Transmission rate [bit/s]	1 Gbit/s
Target transmission distance [km]	Single-mode fiber: 10 km
<b>Transmitter Optical Characteristics</b>	
Center wavelength [nm]	1310 nm (RX) 1490 nm (TX)
Maximum Tx optical power [dBm]	-3.0 dBm
Minimum Tx optical power [dBm]	-9.0 dBm
Minimum extinction ratio [dB]	6 dB
<b>Receiver Optical Characteristics</b>	
Rx sensitivity [dBm]	-19.5 dBm
Overload power [dBm]	-3.0 dBm
<b>NOTE</b> Supports the single-fiber bidirectional function. Single-fiber bidirectional (BIDI) optical modules must be used in pairs. For example, SFP-GE-LX-SM1490-BIDI must be used with SFP-GE-LX-SM1310-BIDI.	

## 6.6 GE-CWDM eSFP Optical Modules

## 6.6.1 CWDM-SFPGE-1471

**Table 6-33** CWDM-SFPGE-1471 specifications

Item	Value
<b>Basic Information</b>	
Module name	CWDM-SFPGE-1471
Part Number	02310LPN
Model	CWDM-SFPGE-1471
Form factor	eSFP
Application standard	GE-CWDM
Connector type	LC
Optical fiber type	SMF
Working case temperature [°C(°F)]	0°C to 70°C (32°F to 158°F)
Transmission rate [bit/s]	1 Gbit/s
Target transmission distance [km]	Single-mode fiber: 80 km
<b>Transmitter Optical Characteristics</b>	
Center wavelength [nm]	1471 nm
Maximum Tx optical power [dBm]	5.0 dBm
Minimum Tx optical power [dBm]	0 dBm
Minimum extinction ratio [dB]	8.5 dB
<b>Receiver Optical Characteristics</b>	
Rx sensitivity [dBm]	-28.0 dBm
Overload power [dBm]	-9.0 dBm

## 6.6.2 CWDM-SFPGE-1491

**Table 6-34** CWDM-SFPGE-1491 specifications

Item	Value
<b>Basic Information</b>	
Module name	CWDM-SFPGE-1491
Part Number	02310LPK

Item	Value
Model	CWDM-SFPGE-1491
Form factor	eSFP
Application standard	GE-CWDM
Connector type	LC
Optical fiber type	SMF
Working case temperature [°C(°F)]	0°C to 70°C (32°F to 158°F)
Transmission rate [bit/s]	1 Gbit/s
Target transmission distance [km]	Single-mode fiber: 80 km
<b>Transmitter Optical Characteristics</b>	
Center wavelength [nm]	1491 nm
Maximum Tx optical power [dBm]	5.0 dBm
Minimum Tx optical power [dBm]	0 dBm
Minimum extinction ratio [dB]	8.5 dB
<b>Receiver Optical Characteristics</b>	
Rx sensitivity [dBm]	-28.0 dBm
Overload power [dBm]	-9.0 dBm

### 6.6.3 CWDM-SFPGE-1511

**Table 6-35** CWDM-SFPGE-1511 specifications

Item	Value
<b>Basic Information</b>	
Module name	CWDM-SFPGE-1511
Part Number	02310LPH
Model	CWDM-SFPGE-1511
Form factor	eSFP
Application standard	GE-CWDM
Connector type	LC
Optical fiber type	SMF
Working case temperature [°C(°F)]	0°C to 70°C (32°F to 158°F)

Item	Value
Transmission rate [bit/s]	1 Gbit/s
Target transmission distance [km]	Single-mode fiber: 80 km
<b>Transmitter Optical Characteristics</b>	
Center wavelength [nm]	1511 nm
Maximum Tx optical power [dBm]	5.0 dBm
Minimum Tx optical power [dBm]	0 dBm
Minimum extinction ratio [dB]	8.5 dB
<b>Receiver Optical Characteristics</b>	
Rx sensitivity [dBm]	-28.0 dBm
Overload power [dBm]	-9.0 dBm

## 6.6.4 CWDM-SFPGE-1531

**Table 6-36** CWDM-SFPGE-1531 specifications

Item	Value
<b>Basic Information</b>	
Module name	CWDM-SFPGE-1531
Part Number	02310LPL
Model	CWDM-SFPGE-1531
Form factor	eSFP
Application standard	GE-CWDM
Connector type	LC
Optical fiber type	SMF
Working case temperature [°C(°F)]	0°C to 70°C (32°F to 158°F)
Transmission rate [bit/s]	1 Gbit/s
Target transmission distance [km]	Single-mode fiber: 80 km
<b>Transmitter Optical Characteristics</b>	
Center wavelength [nm]	1531 nm
Maximum Tx optical power [dBm]	5.0 dBm
Minimum Tx optical power [dBm]	0 dBm

Item	Value
Minimum extinction ratio [dB]	8.5 dB
<b>Receiver Optical Characteristics</b>	
Rx sensitivity [dBm]	-28.0 dBm
Overload power [dBm]	-9.0 dBm

## 6.6.5 CWDM-SFPGE-1551

**Table 6-37** CWDM-SFPGE-1551 specifications

Item	Value
<b>Basic Information</b>	
Module name	CWDM-SFPGE-1551
Part Number	02312AXN
Model	CWDM-SFPGE-1551
Form factor	eSFP
Application standard	GE-CWDM
Connector type	LC
Optical fiber type	SMF
Working case temperature [°C(°F)]	0°C to 70°C (32°F to 158°F)
Transmission rate [bit/s]	1 Gbit/s
Target transmission distance [km]	Single-mode fiber: 80 km
<b>Transmitter Optical Characteristics</b>	
Center wavelength [nm]	1551 nm
Maximum Tx optical power [dBm]	5.0 dBm
Minimum Tx optical power [dBm]	0 dBm
Minimum extinction ratio [dB]	8.5 dB
<b>Receiver Optical Characteristics</b>	
Rx sensitivity [dBm]	-28.0 dBm
Overload power [dBm]	-9.0 dBm

## 6.6.6 CWDM-SFPGE-1571

**Table 6-38** CWDM-SFPGE-1571 specifications

Item	Value
<b>Basic Information</b>	
Module name	CWDM-SFPGE-1571
Part Number	02312AXM
Model	CWDM-SFPGE-1571
Form factor	eSFP
Application standard	GE-CWDM
Connector type	LC
Optical fiber type	SMF
Working case temperature [°C(°F)]	0°C to 70°C (32°F to 158°F)
Transmission rate [bit/s]	1 Gbit/s
Target transmission distance [km]	Single-mode fiber: 80 km
<b>Transmitter Optical Characteristics</b>	
Center wavelength [nm]	1571 nm
Maximum Tx optical power [dBm]	5.0 dBm
Minimum Tx optical power [dBm]	0 dBm
Minimum extinction ratio [dB]	8.5 dB
<b>Receiver Optical Characteristics</b>	
Rx sensitivity [dBm]	-28.0 dBm
Overload power [dBm]	-9.0 dBm

## 6.6.7 CWDM-SFPGE-1591

**Table 6-39** CWDM-SFPGE-1591 specifications

Item	Value
<b>Basic Information</b>	
Module name	CWDM-SFPGE-1591
Part Number	02312AXK

Item	Value
Model	CWDM-SFPGE-1591
Form factor	eSFP
Application standard	GE-CWDM
Connector type	LC
Optical fiber type	SMF
Working case temperature [°C(°F)]	0°C to 70°C (32°F to 158°F)
Transmission rate [bit/s]	1 Gbit/s
Target transmission distance [km]	Single-mode fiber: 80 km
<b>Transmitter Optical Characteristics</b>	
Center wavelength [nm]	1591 nm
Maximum Tx optical power [dBm]	5.0 dBm
Minimum Tx optical power [dBm]	0 dBm
Minimum extinction ratio [dB]	8.5 dB
<b>Receiver Optical Characteristics</b>	
Rx sensitivity [dBm]	-28.0 dBm
Overload power [dBm]	-9.0 dBm

## 6.6.8 CWDM-SFPGE-1611

**Table 6-40** CWDM-SFPGE-1611 specifications

Item	Value
<b>Basic Information</b>	
Module name	CWDM-SFPGE-1611
Part Number	02310LPJ
Model	CWDM-SFPGE-1611
Form factor	eSFP
Application standard	GE-CWDM
Connector type	LC
Optical fiber type	SMF
Working case temperature [°C(°F)]	0°C to 70°C (32°F to 158°F)

Item	Value
Transmission rate [bit/s]	1 Gbit/s
Target transmission distance [km]	Single-mode fiber: 80 km
<b>Transmitter Optical Characteristics</b>	
Center wavelength [nm]	1611 nm
Maximum Tx optical power [dBm]	5.0 dBm
Minimum Tx optical power [dBm]	0 dBm
Minimum extinction ratio [dB]	8.5 dB
<b>Receiver Optical Characteristics</b>	
Rx sensitivity [dBm]	-28.0 dBm
Overload power [dBm]	-9.0 dBm

## 6.7 GE-DWDM eSFP Optical Modules

### 6.7.1 DWDM-SFPGE-1560-61

Table 6-41 DWDM-SFPGE-1560-61 specifications

Item	Value
<b>Basic Information</b>	
Module name	DWDM-SFPGE-1560-61
Part Number	02310LLE
Model	DWDM-SFPGE-1560-61
Form factor	eSFP
Application standard	GE-DWDM
Connector type	LC
Optical fiber type	SMF
Working case temperature [°C(°F)]	0°C to 70°C (32°F to 158°F)
Transmission rate [bit/s]	1 Gbit/s
Target transmission distance [km]	Single-mode fiber: 120 km
<b>Transmitter Optical Characteristics</b>	
Center wavelength [nm]	1560.61 nm



Item	Value
Maximum Tx optical power [dBm]	4.0 dBm
Minimum Tx optical power [dBm]	0 dBm
Minimum extinction ratio [dB]	8.2 dB
<b>Receiver Optical Characteristics</b>	
Rx sensitivity [dBm]	-28.0 dBm
Overload power [dBm]	-8.0 dBm

## 6.8 GE SFP Copper Modules

### 6.8.1 SFP-1000BaseT (02314171)

Table 6-42 SFP-1000BaseT specifications

Item	Value
<b>Basic Information</b>	
Module name	SFP-1000BaseT
Part Number	02314171
Model	SFP-1000BaseT
Form factor	SFP
Application standard	1000BASE-T
Connector type	RJ45
Optical fiber type	-
Transmission rate [bit/s]	10 Mbit/s 100 Mbit/s 1 Gbit/s
Target transmission distance [km]	Ethernet cable: 0.1 km
<b>Transmitter Optical Characteristics</b>	
Center wavelength [nm]	-
Maximum Tx optical power [dBm]	-
Minimum Tx optical power [dBm]	-
Minimum extinction ratio [dB]	-

Item	Value
<b>Receiver Optical Characteristics</b>	
Rx sensitivity [dBm]	-
Overload power [dBm]	-
<b>NOTE</b> The supported rate depends on the interface. Surge protection specifications: $\pm 1$ kV in common mode	

## 6.8.2 SFP-1000BaseT (02313URG)

**Table 6-43** SFP-1000BaseT specifications

Item	Value
<b>Basic Information</b>	
Module name	SFP-1000BaseT
Part Number	02313URG
Model	SFP-1000BaseT
Form factor	SFP
Application standard	1000BASE-T
Connector type	RJ45
Optical fiber type	-
Transmission rate [bit/s]	10 Mbit/s 100 Mbit/s 1 Gbit/s
Target transmission distance [km]	Ethernet cable: 0.1 km
<b>Transmitter Optical Characteristics</b>	
Center wavelength [nm]	-
Maximum Tx optical power [dBm]	-
Minimum Tx optical power [dBm]	-
Minimum extinction ratio [dB]	-
<b>Receiver Optical Characteristics</b>	
Rx sensitivity [dBm]	-
Overload power [dBm]	-

Item	Value
<b>NOTE</b>	
The supported rate depends on the interface.	
Surge protection specifications: $\pm 1$ kV in common mode	

### 6.8.3 SFP-GE-TV

**Table 6-44** SFP-GE-TV specifications

Item	Value
<b>Basic Information</b>	
Module name	SFP-GE-TV
Part Number	02314BDD
Model	SFP-GE-TV
Form factor	SFP
Application standard	1000BASE-T
Connector type	RJ45
Optical fiber type	-
Transmission rate [bit/s]	10 Mbit/s 100 Mbit/s 1 Gbit/s
Target transmission distance [km]	Ethernet cable: 0.1 km
<b>Transmitter Optical Characteristics</b>	
Center wavelength [nm]	-
Maximum Tx optical power [dBm]	-
Minimum Tx optical power [dBm]	-
Minimum extinction ratio [dB]	-
<b>Receiver Optical Characteristics</b>	
Rx sensitivity [dBm]	-
Overload power [dBm]	-
<b>NOTE</b>	
The supported rate depends on the interface.	
Surge protection specifications: $\pm 1$ kV in common mode	